differential geometry

lieven le bruyn, uia 1998



Contents

1	Manifolds and differentiable manifolds	3
2	Two dimensional compact manifolds	9
2.1	Triangulations of compact surfaces	9
2.2	Classification of compact surfaces	16
2.3	Topological invariants of compact surfaces.	19
3	Vectorbundles	24
3.1	Tangentbundle and Riemannian metrics	24
3.2	Vectorfields, forms and tensors.	33
3.3	de Rham cohomology	37
4	Lie groups	46
4.1	Lie groups and Lie algebras.	47
4.2	Structure groups and bundles.	48
4.3	Fundamental group and covers.	52
4.4	Spin structures.	56
5	Connections.	62
5.1	Levi-Civita connection.	66
5.2	The Yang-Mills connections.	68
5.3	Four dimensional manifolds	73
5.4	Exotic structures on \mathbb{R}^4	76
5.5	Three dimensional manifolds	84
6	Noncommutative manifolds	92
6.1	C^* -algebras and topology.	92
6.2	The Dirac operator	94
6.3	Connes' standard model.	97

1 Manifolds and differentiable manifolds

Roughly speaking, a manifold is a topological space which locally looks like \mathbb{R}^n , standard affine n -space over the real numbers \mathbb{R} . We recall some basic facts about topology and analysis on \mathbb{R}^n .

For an integer $n > 0$ let \mathbb{R}^n be the product space of ordered n -tuples of real numbers

$$\mathbb{R}^n = \{(a_1, \dots, a_n) \mid a_i \in \mathbb{R}\}.$$

For $1 \leq i \leq n$ we denote with u_i the coordinate function on \mathbb{R}^n , that is, $u_i(a_1, \dots, a_n) = a_i$.

An open set of \mathbb{R}^n will be a set which is open in the standard metric topology induced by the standard metric d on \mathbb{R}^n , thus if $a = (a_1, \dots, a_n)$ and $b = (b_1, \dots, b_n)$ are points in \mathbb{R}^n , then

$$d(a, b) = \sqrt{\sum_{i=1}^n (a_i - b_i)^2}.$$

The concept of differentiability is based ultimately on the definition of a derivative in elementary calculus. With ∂_i we will denote the partial derivative $\frac{\partial}{\partial u_i}$. Recall that a map

$$U \xrightarrow{f} \mathbb{R}$$

from an open set $U \subset \mathbb{R}^n$ is called a C^r -function on U if it possesses continuous partial derivatives on U of all orders $\leq r$, that is, the functions

$$\frac{\partial^k f}{\partial u_{i_1} \dots \partial u_{i_k}}$$

are continuous on U for all $0 \leq k \leq r$ and all $1 \leq i_j \leq n$.

If f is merely a continuous function from U to \mathbb{R} , then f is a C^0 -function on U .

If f is a C^r -function on U for all r , then f is said to be a C^∞ -function on U .

More generally, a function

$$U \xrightarrow{f} \mathbb{R}^k$$

is said to be a C^r -function on U if all the component functions $f_i = u_i \circ f$ are C^r -functions on U for all $1 \leq i \leq k$, that is, for all points $p \in U$

$$f(p) = (f_1(p), \dots, f_k(p)) \in \mathbb{R}^k.$$

We are now ready to define a **manifold**. Let M be a Hausdorff topological space. We define the following concepts :

- An n -dimensional chart on M is a pair (ϕ, U) of an open subset U of M and a homeomorphism ϕ from U to an open subset of \mathbb{R}^n .

- Two charts (ϕ_1, U_1) and (ϕ_2, U_2) are C^r -related whenever the maps $\phi_1 \circ \phi_2^{-1}$ and $\phi_2 \circ \phi_1^{-1}$ are C^r -functions on $\phi_2(U_1 \cap U_2)$ resp. on $\phi_1(U_1 \cap U_2)$.
- An n -dimensional C^r -subatlas on M is a collection of n -dimensional charts $\{(\phi_i, U_i)\}$ such that $\cup_i U_i = M$ and any two pairs are C^r -related.
- An n -dimensional C^r -atlas on M is a maximal collection of C^r -related charts on M .
- If a C^r -atlas contains a C^r -subatlas, we say that the subatlas induces the atlas.

Definition 1.1 M is said to be an n -dimensional C^r -manifold if M has a n -dimensional C^r -atlas.

If $r = 0$ then M is said to be a (topological) manifold. If $r > 0$, then M is said to be a differentiable manifold.

We can restrict to C^∞ -manifolds since a result of Whitney asserts that any C^r -atlas on M with $r > 0$ contains a C^∞ -atlas. On the other hand, Kervaire has produced examples of C^0 -manifolds having no C^1 -atlas.

Example 1.2 (n -sphere S^n)

Consider the closed subset

$$S^n = \{(x_1, \dots, x_{n+1}) \in \mathbb{R}^{n+1} \mid \sum_{i=1}^{n+1} x_i^2 = 1\}.$$

S^n is an n -dimensional differentiable manifold with charts given as follows.

On $U_1 = S^n - \{(0, \dots, 0, 1)\}$ we put

$$\phi_1(x_1, \dots, x_{n+1}) = \left(\frac{x_1}{1 - x_{n+1}}, \dots, \frac{x_n}{1 - x_{n+1}} \right)$$

and on $U_2 = S^n - \{(0, \dots, 0, -1)\}$ we put

$$\phi_2(x_1, \dots, x_{n+1}) = \left(\frac{x_1}{1 + x_{n+1}}, \dots, \frac{x_n}{1 + x_{n+1}} \right)$$

Verify that these charts are C^1 -related.

Example 1.3 (n -dimensional torus T^n)

Let $\{w_1, \dots, w_n\}$ be linearly independent vectors in \mathbb{R}^n . Define an equivalence relation on \mathbb{R}^n by saying that $z_1, z_2 \in \mathbb{R}^n$ are equivalent if there are $m_1, \dots, m_n \in \mathbb{Z}$ such that

$$z_1 - z_2 = \sum_{i=1}^n m_i w_i$$

(verify that this is indeed an equivalence relation).

The torus T^n is the set of equivalence classes with the induced (quotient) topology. Verify that T^n can be made a differentiable manifold by taking as charts $(\pi(U_i), \pi^{-1})$ where U_i is an open subset of \mathbb{R}^n containing no pair of equivalent points and π is the projection map.

Every n -dimensional chart (ϕ, U) on M induces a set of real valued functions on U defined by

$$x_i = u_i \circ \phi \text{ for } 1 \leq i \leq n$$

The functions x_i are called **local coordinate functions** on M with domain U . Let U be an open set of an n -dimensional C^r -manifold M . Consider a function

$$U \xrightarrow{f} \mathbb{R}$$

Then f is said to be a C^s -function if $f \circ \phi^{-1}$ is a C^s -function on $\phi(U \cap V)$ for every chart (ϕ, V) .

More generally, consider a function

$$U \xrightarrow{f} N$$

where N is a d -dimensional C^k -manifold. then f is said to be a C^s -function on U if f is continuous and for every C^s -function

$$W \xrightarrow{g} \mathbb{R}$$

on an open subset W of N we have that $g \circ f$ is a C^s -function.

This allows us to define a category **MAN** of manifolds and continuous morphisms and a category **DIFF** of differentiable manifolds with C^∞ -functions. An isomorphism in **MAN** is called a homeomorphism, one in **DIFF** is called a diffeomorphism.

The main objective of topology (resp. differential geometry) is to classify manifolds (resp. differentiable manifolds) up to homeomorphism (resp. diffeomorphism). In recent years significant progress has been made in the classification of 3- and 4-dimensional manifolds.

The only one dimensional manifolds are the real line \mathbb{R} and the unit circle S^1 , the latter being the only compact one. Two dimensional compact manifolds are classified by their genus and orientability character as we will see in the next section.

In three dimensions, there exists a program by Thurston about the possible classification of compact three dimensional manifolds. In higher dimensions, the multitude of compact manifolds makes a classification useless and impossible.

In dimension ≤ 3 , each manifold carries a unique differentiable structure and so in dimension at most three the classification of manifolds and of differentiable manifolds coincide.

William Paul Thurston

Born : 30 october 1946 in Washington D.C. (USA)



Bill Thurston studied at New College, Sarasota, Florida. He received his B.S. from there in 1967 and moved to the University of California at Berkeley to undertake research under Morris Hirsch's and Stephen Smale's supervision. He was awarded his doctorate in 1972 for a thesis entitled "Foliations of 3-manifolds which are circle bundles." This work showed the existence of compact leaves in foliations of 3-manifolds. After completing his Ph.D., Thurston spent the academic year 1972-73 at the Institute for Advanced Study at Princeton. Then, in 1973, he was appointed an assistant professor of mathematics at Massachusetts Institute of Technology. In 1974 he was appointed professor of mathematics at Princeton University. Thurston's contributions led to him being awarded a Fields Medal in 1982. In fact the 1982 Fields Medals were announced at a meeting of the General Assembly of the International Mathematical Union in Warsaw in early August 1982. They were not presented until the International Congress in Warsaw which could not be held in 1982 as scheduled and was delayed until the following year. Lectures on the work of Thurston which led to his receiving the Medal were made at the 1983 International Congress. Wall, giving that address, said:- 'Thurston has fantastic geometric insight and vision: his ideas have completely revolutionized the study of topology in 2 and 3 dimensions, and brought about a new and fruitful interplay between analysis, topology and geometry.' Wall goes on to describe Thurston's work in more detail:- 'The central new idea is that a very large class of closed 3-manifolds should carry a hyperbolic structure - be the quotient of hyperbolic space by a discrete group of isometries, or equivalently, carry a metric of constant negative curvature. Although this is a natural analogue of the situation for 2-manifolds, where such a result is given by Riemann's uniformisation theorem, it is much less plausible - even counter-intuitive - in the 3-dimensional situation.' Kleinian groups, which are discrete isometry groups of hyperbolic 3-space, were first studied by Poincaré and a fundamental finiteness theorem was proved by Ahlfors. Thurston's work on Kleinian groups yielded many new results and established a well known conjecture. Thurston's work is summarized by Wall :- 'Thurston's work has had an enormous influence on 3-dimensional topology. This area has a strong tradition of 'bare hands' techniques and relatively little interaction with other subjects. Direct arguments remain essential, but 3-dimensional topology has now firmly rejoined the main stream of mathematics.'

In higher dimensions this is no longer true. As mentioned before, Kervaire gave examples of manifolds without a differentiable structure and Kervaire and Milnor showed that there can be different differentiable structures on S^n . For example on S^7 there are precisely 28 non diffeomorphic differentiable structures, on S^{15} there are 16256 such structures.

John Willard Milnor

Born : 20 february 1931 in Orange, New Jersey (USA)

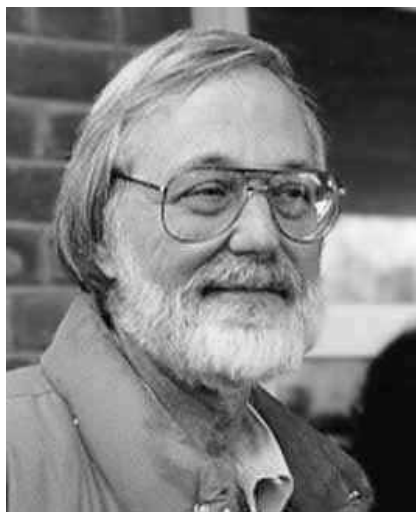

John Milnor was educated at the University of Princeton, receiving his A.B. in 1951. He began research at Princeton after graduating and, in 1953 before completing his doctoral studies, he was appointed to the faculty in Princeton. In 1954 Milnor received his doctorate for his thesis "Isotopy of Links" written under Ralph Fox's supervision. Milnor remained on the staff at Princeton where he was an Alfred P Sloan fellow from 1955 until 1959. He was promoted to professor in 1960 then, in 1962, Milnor was appointed to the Henry Putman chair. Milnor was awarded a Fields Medal at the 1962 International Congress of Mathematicians in Stockholm. His most remarkable achievement, which played a major role in the award of the Fields Medal, was his proof that a 7-dimensional sphere can have several differential structures. This work opened up the new field of differential topology. Milnor showed that 28 different differentiable structures exist on the seven-dimensional sphere. He distinguished between these structures using numerical invariants based on the Todd polynomials. The Todd polynomials were first studied in algebraic geometry and it is surprising that they play this fundamental role in classification of manifolds. The reason that Milnor could use them to distinguish the differential properties of manifolds is because they have arithmetic properties, involving the Bernoulli numbers, which reflect in a deep and not fully understood way these differential properties. In differential geometry we have Milnor's theorem, which shows that the total curvature of a knot is at least 4π . Among other results discussed are Milnor's result showing that we cannot necessarily "hear the shape" of a 16-dimensional torus, and another result giving upper and lower bounds on the number of distinct words of a given length in a finitely generated subgroup of the fundamental group.

In dimension 4, the understanding of differentiable structures owes important progress to the work of S. Donaldson. In particular, it follows from his work that there exist exotic structures on \mathbb{R}^4 , that is differentiable structures not diffeomorphic to the usual manifold structure on \mathbb{R}^4 .

2 Two dimensional compact manifolds

Recall that a topological space is said to be compact if every open covering contains a finite subcover. A topological space is said to be connected if it cannot be decomposed in two disjoint clopen subsets.

In this section we will prove the classification of two dimensional compact connected manifolds (or **surfaces** for short). Recall that in dimension ≤ 3 every homeomorphism class of manifolds can be equipped with a unique differentiable structure. Hence it suffices to classify manifolds up to homeomorphism.

First we will construct a 'cut-and-paste'-model for a compact surface, a so called triangulation. Next we will use this triangulation to prove the classification result and finally we will give topological invariants (genus and orientability character) for compact surfaces.

2.1 Triangulations of compact surfaces

Let us first give some examples of surfaces, that is, of two dimensional compact connected manifolds. The simplest example is the two sphere S^2 . Another example we have seen is the two-dimensional torus T^2 . We will give some slightly different descriptions of T^2

- T^2 is homeomorphic to the product $S^1 \times S^1$ of two circles.
- T^2 is homeomorphic to the closed surface in \mathbb{R}^3 determined by

$$\{(x, y, z) \in \mathbb{R}^3 \mid (\sqrt{x^2 + y^2} - 2)^2 + z^2 = 1\}$$

which is the set obtained by rotating the circle $(x - 2)^2 + z^2 = 1$ in the (x, z) -plane about the z -axis.

- T^2 is the space homeomorphic to the space obtained from the unit square X in \mathbb{R}^2 ,

$$\{(x, y) \in \mathbb{R}^2 \mid 0 \leq x \leq 1, 0 \leq y \leq 1\}$$

obtained by identifying opposite sides of the square X . That is, the points $(0, y)$ and $(1, y)$ are identified for all $0 \leq y \leq 1$ and similarly $(x, 0)$ and $(x, 1)$ are identified for all $0 \leq x \leq 1$.

The last description allows us to write T^2 symbolically by a diagram

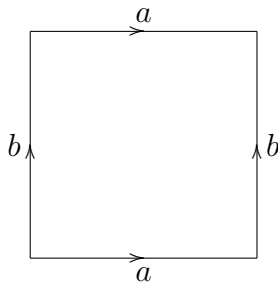

By this we mean that sides that are to be identified are labeled with the same letter and the identification should be made so that the directions indicated by the arrows agree.

So far, S^2 and T^2 were homeomorphic to surfaces in \mathbb{R}^3 . In general, H. Whitney proved in 1936 that any n -dimensional differentiable manifold can be embedded into \mathbb{R}^{2n+1} .

Hassler Whitney

Born : 23 march 1907 in New York (USA)

Died : 10 may 1989 in Mont Dents Blanches (Switzerland)



Hassler Whitney attended Yale University where he received his first degree in 1928, then continued to undertake mathematical research at the University of Harvard from where his doctorate was awarded in 1932. His doctorate was awarded for a dissertation "The Coloring of Graphs" written under Birkhoff's supervision. He continued to work at Harvard, being an instructor in mathematics from 1930 until 1935, although the years 1931-33 were spent as a National Research Council Research Fellow. From 1935 he was promoted to assistant professor, then from 1940 associate professor. Harvard made him a full professor in 1946 and he held this professorship until he accepted an offer from the Institute of Advanced Study at Princeton of a chair in 1952. Whitney's main work was in topology, particularly in the theory of manifolds. Continuing work started by Veblen and Henry Whitehead, Whitney produced fundamental work in differential topology in 1935. Whitney also wrote on graph theory, in particular the coloring of graphs and chromatic polynomials. Other work on algebraic varieties and integration theory was important. Princeton was to remain Whitney's base from 1952 until he retired in 1977. The year before he retired he was awarded the National Medal of Science. Then in 1983 he received the Wolf Prize and, two years later, the Steele Prize.

In the case of surfaces ($n = 2$) there is no reason why any surface should be

embeddable in \mathbb{R}^3 . An example of a surface not embeddable in \mathbb{R}^3 is

Example 2.1 (the real projective plane \mathbb{P}^2)

\mathbb{P}^2 is the quotient space of the 2-sphere S^2 obtained by identifying every pair of diametrically opposite points.

Recall that \mathbb{P}^2 is the space of lines through the origin in \mathbb{R}^3 and clearly any such line is determined by its intersections points with the unit sphere (which are opposite points).

\mathbb{P}^2 can also be viewed as the space obtained from the closed upper hemisphere

$$H = \{(x, y, z) \in S^2 \mid z \geq 0\}$$

by identifying diametrically opposite points on the boundary (the equator). As H is homeomorphic to the closed unit square we can represent \mathbb{P}^2 symbolically by the diagram

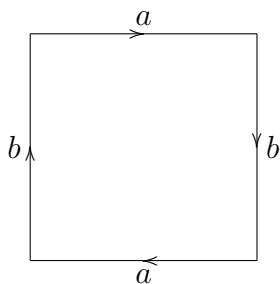

Although one cannot embed \mathbb{P}^2 in \mathbb{R}^3 there exists an image of \mathbb{P}^2 to \mathbb{R}^3 which is called **Boy's surface**. It contains one continuous double point curve, which meets itself in a triple point. These are the only self-intersections in Boy's surface. There are no singularities in this image surface. Below a picture of the front and back of Boy's surface.

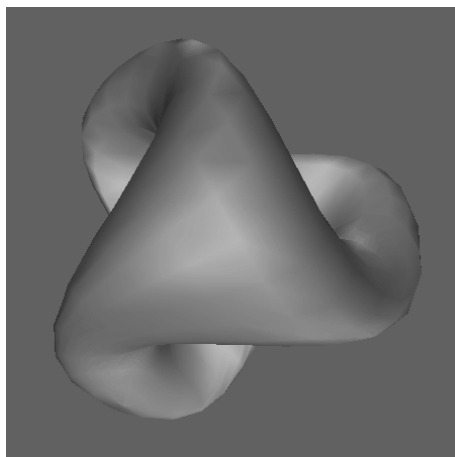
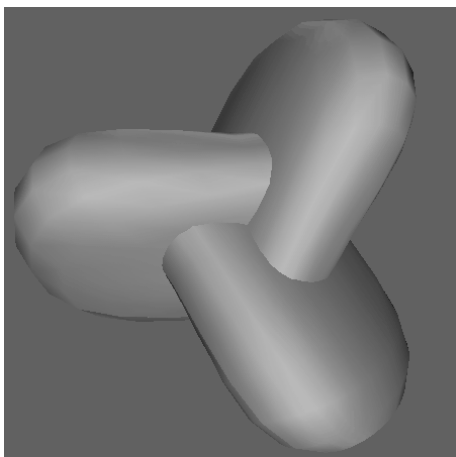

If S_1 and S_2 are disjoint surfaces then their **connected sum**

$$S_1 \# S_2$$

is formed by cutting a small circular hole in each surface and then gluing the two surfaces together along the boundaries of the holes.

If S_i are surfaces, then it is easy to see that the following relations hold (here equality means 'homeomorphic to')

- $S_i \# S^2 = S_i$
- $S_i \# S_j = S_j \# S_i$
- $(S_i \# S_j) \# S_k = S_i \# (S_j \# S_k)$

In short, the connected sum operation makes the homeomorphism classes of surfaces into a semigroup with unit element S^2 . Note however that it is not a group (inverses do not exist).

Example 2.2 ($\mathbb{P}^2 \# \mathbb{P}^2$)

The connected sum operation can be symbolically presented as

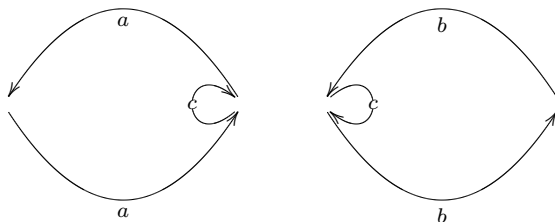

After gluing we obtain a surface represented by the following identifications

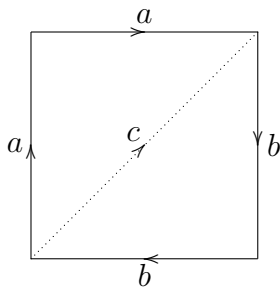

Example 2.3 ($T^2 \# T^2$)

Verify similarly that the connected sum of two T^2 's can be symbolically represented

by the following identification polygon

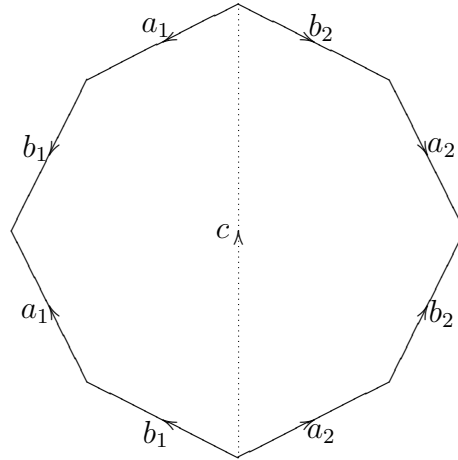

Again we mean by this the surface obtained from the closed polygon in \mathbb{R}^2 where sides are to be identified when labeled by the same letter, and the identifications should be made so that the directions indicated by the arrows agree.

Observe that all surfaces constructed so far are quotients of closed $2n$ -gons in \mathbb{R}^2 where the edges are identified in pairs in a specific manner. Also the 2-sphere S^2 fits in this framework as the quotient space of the following 2-gon with identification

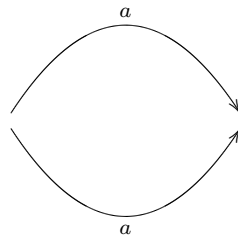

For, cut S^2 open along a line joining the two poles.

We now introduce a rather obvious and convenient method of indicating precisely which paired edges are to be identified in such a polygon. Start at a definite vertex, proceed around the boundary of the polygon recording the letters assigned to the different sides in succession. If the arrow on a side points in the opposite direction that we are going around the boundary we write the letter for that side with the exponent -1 . For example, with the above conventions we have the following symbols associated to the surfaces

- $S^2 : aa^{-1}$.
- $T^2 : aba^{-1}b^{-1}$.
- $\mathbb{P}^2 : abab$ or aa .

- $\mathbb{P}^2 \# \mathbb{P}^2$: $aabb$ and more generally the connected sum of n copies of \mathbb{P}^2 has symbol

$$a_1 a_1 a_2 a_2 \dots a_n a_n.$$

- $T^2 \# T^2$: $a_1 b_1 a_1^{-1} b_1^{-1} a_2 b_2 a_2^{-1} b_2^{-1}$ and more generally the connected sum of n copies of T^2 has symbol

$$a_1 b_1 a_1^{-1} b_1^{-1} a_2 b_2 a_2^{-1} b_2^{-1} \dots a_n b_n a_n^{-1} b_n^{-1}.$$

Our first job is to prove that any compact surface is homeomorphic to such a quotient space. For this we need that any surface is triangulated, that is, divided into triangles which fit together nicely.

Definition 2.4 A **triangulation** of a compact surface S consists of a finite family of closed subsets $\{T_1, T_2, \dots, T_n\}$ that cover S and such that each T_i is homeomorphic to a closed triangle in \mathbb{R}^2 . Using these homeomorphisms we can speak of 'vertices' and 'edges' of these 'triangles' T_i .

It is required that two distinct triangles T_i and T_j either be disjoint, have a single vertex in common or have one entire edge in common.

We can regard a triangulated surface as having been constructed by gluing together the various triangles in a certain way. It has been proved by T. Rado in 1925 that any compact surface can be triangulated.

Tibor Rado

Born : 2 june 1895 in Budapest (Hungary)

Died : 12 december 1965 in New Smyrna Beach, Florida (USA)



Tibor Radó enlisted in 1915 and fought on the Russian front before being captured and imprisoned for four years. While he was in prison, the only books he had to read were on mathematics. After his release he went to Szegeed University, taking a Ph.D. under Riesz. In 1929 he went to the USA and held posts at Harvard and Rice before being appointed to a chair at Ohio State University. Radó; worked on conformal mappings, real analysis, calculus of variations, partial differential equations, integration theory and topology. He worked on the Plateau Problem and found the solution independently of Douglas. He also worked on surface measure continuing the work of Lebesgue and Riesz. Tibor Radó; was the American Mathematical Society Colloquium Lecturer in 1945.

Example 2.5 *Show that the set of triangles*

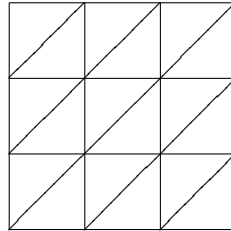

is a triangulation for the torus T^2 but is not a triangulation for \mathbb{P}^2 (compare upper left and bottom right triangles).

Lemma 2.6 *Consider a triangulation of a compact surface.*

1. *Each edge is an edge of precisely two triangles.*
2. *For v a vertex we can arrange the triangles having vertex v in cyclic order say $T_0, T_1, \dots, T_{k-1}, T_k = T_0$ such that T_i and T_{i+1} have an edge in common.*

Proof. Follows from the fact that each point of an edge (or v) has an open neighborhood homeomorphic to the open unit disc U^2 . □

Lemma 2.7 *Let n be the number of triangles in a triangulation of a compact surface S . Then, we can order the triangles T_1, T_2, \dots, T_n such that T_i has an edge e_i in common with at least one of the triangles T_1, \dots, T_{i-1} .*

Proof. Take any triangle as T_1 , choose T_2 to be a triangle having an edge in common with T_1 . Take T_3 to be a triangle having an edge in common with T_1 or T_2 etc. If this process would stop prematurely we would have sets $\{T_1, \dots, T_k\}$ and $\{T_{k+1}, \dots, T_n\}$ such that no triangle in the first set has an edge or vertex in common with any triangle in the second set. This contradicts that S is connected. □

Proposition 2.8 *Let S be a compact surface. Then, S is homeomorphic to the quotient space of a closed polygon with an even number of edges which are identified in pairs.*

Proof. Take an ordered triangulation $\{T_1, \dots, T_n\}$ and $\{e_2, \dots, e_n\}$ with properties of the foregoing lemma. Glue triangles t_1 and t_2 in \mathbb{R}^2 along their common edge e'_2 to obtain a polygon P_2 with 4 outer edges homeomorphic to a closed disc D^2 . t_3 has an (necessarily outer) edge e_3 in common with P_2 so glue to obtain a polygon P_3 with 5 outer edges homeomorphic to D^2 . Continue until P_n which is a polygon having $n + 2$ outer edges homeomorphic to D^2 . Consider an outer edge e of P_n . As it belongs to precisely one other triangle in S it has to be identified with another outer edge. Therefore, the number of outer edges of P_n is even and we obtain S as the quotient space of P_n after identifying the outer edges in pairs. \square

2.2 Classification of compact surfaces

In this subsection we will prove the following classification result.

Theorem 2.9 *Any compact surface is homeomorphic to either*

- *the sphere S^2 or to*
- *the connected sum $T^2 \# \dots \# T^2$ of a number of tori or to*
- *the connected sum $\mathbb{P}^2 \# \dots \# \mathbb{P}^2$ of a number of projective planes.*

The strategy of proof is to view S as the quotient space of a polygon with even number of edges which are identified in pairs, consider the associated symbol and manipulate this symbol topologically until one obtains one of the symbols of the situations of the theorem.

If the letter designated to a certain pair of edges occurs in the symbol once with exponent $+1$ and once with exponent -1 we say that it is a pair of edges of the **first kind**. Otherwise it is a pair of edges of the **second kind**.

For example, in the symbol

$$aa^{-1}fbb^{-1}fe^{-1}cgc^{-1}gdd^{-1}e^{-1}$$

the pairs corresponding to a, b, c, d are of the first kind, those corresponding to e, f, g of the second kind.

We can eliminate an adjacent pair of edges of the first kind as illustrated in the following topological operation.

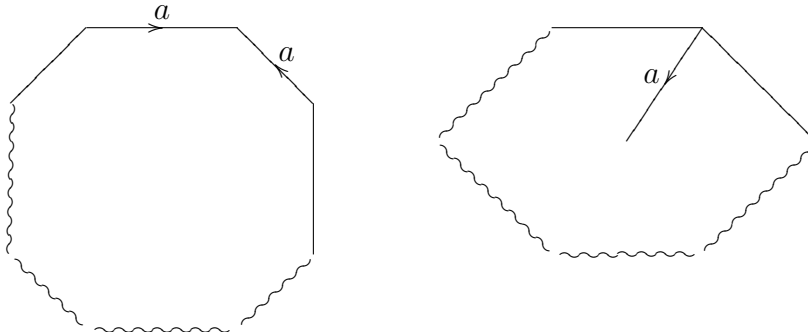

Assume we have made all these reductions.

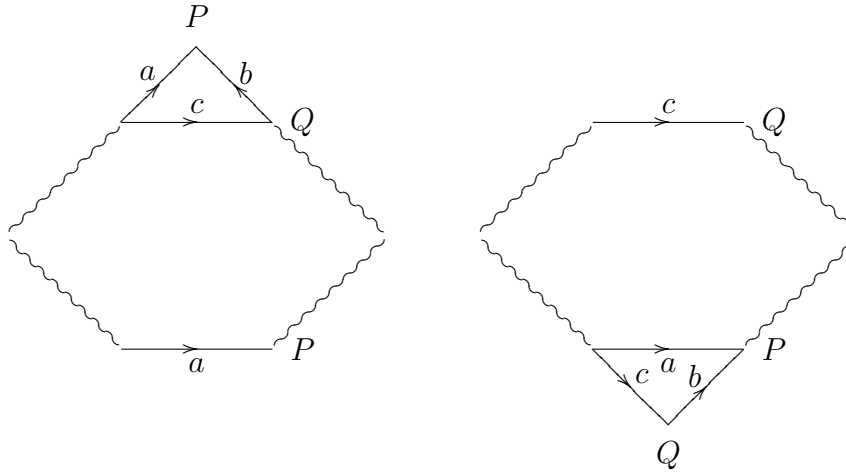

Next, we claim that we may assume that all the vertices of the polygon are identified to a single point in S . Call two vertices of the polygon **equivalent** if they are to be identified in S .

Suppose there are at least two different equivalence classes of vertices, then the polygon must have an adjacent pair of vertices P and Q which are not equivalent. Then, we can perform the topological operation described above to obtain a new polygon having one vertex less in the equivalence class of P and one more in the equivalence class of Q (observe that the edges a and b are not to be identified as otherwise they would be adjacent of the first kind).

Continuing in this way (and eliminating adjacent pairs of first kind when they appear) we obtain a polygon such that all the vertices are to be identified to a single point in S .

Next, we can make any pair of edges of the second kind adjacent by the following topological operation.

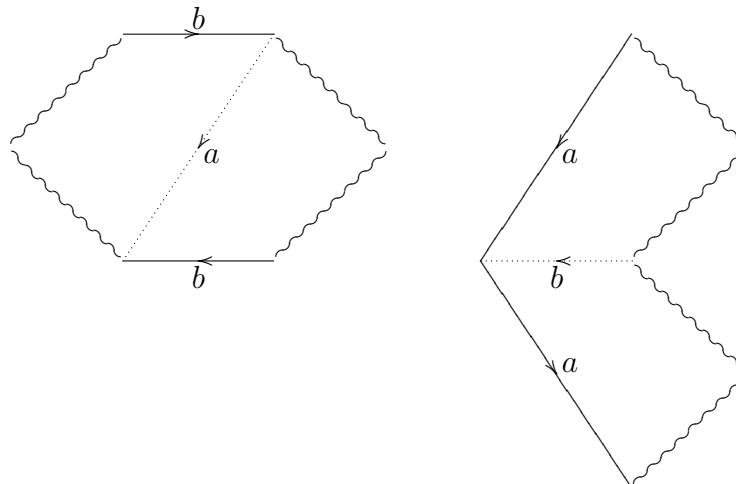

Continue until all pairs of the second kind are adjacent. If there are no pairs of edges of the first kind we are done as we have a polygon with symbol that of the connected sum of projective planes.

If there is at least one pair of edges of the first kind, then there is another one such that the two pairs separate each other, that is, such that in the symbol the pairs appear as $\dots a \dots b \dots a^{-1} \dots b^{-1} \dots$. For otherwise we would have the situation

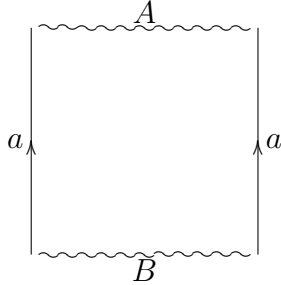

where A and B designate a whole sequence of edges and no edge from A is identified with an edge from B . This contradicts the fact that both endpoints of c are identified in S .

Hence if we have two pairs of edges of the first kind we can perform the following sequence of topological moves to transform the polygon such that the four edges in questions are consecutive.

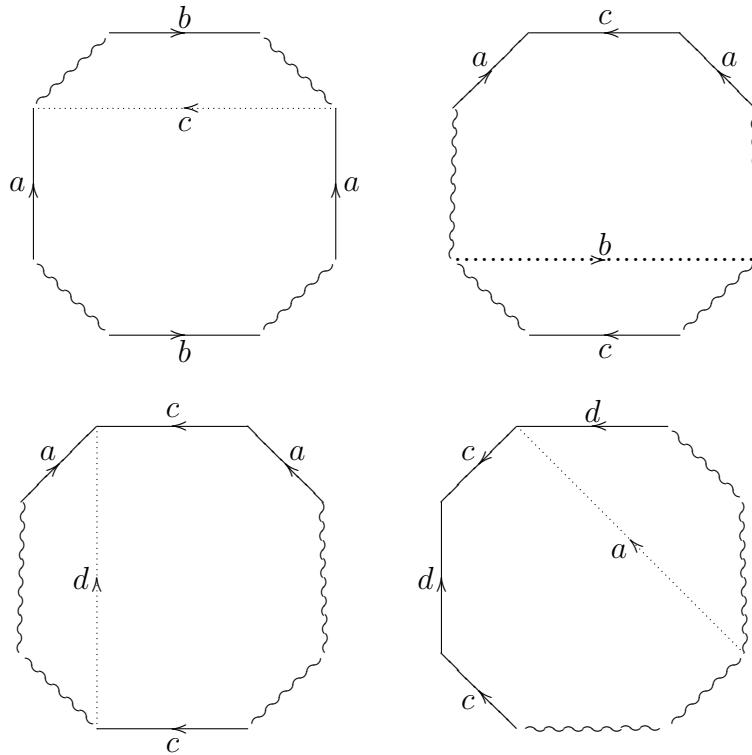

By repeating these procedures we are reduced to polygons with symbols such that all pairs of edges of the second kind are adjacent and all couples of pairs of

edges of the first kind are adjacent groups of four. That is, our surface S is the connected sum of tori and of projective planes.

The final ingredient of the proof is contained in the following

Exercise 2.10 *Show that the connected sum of a torus and a projective plane is homeomorphic to the connected sum of three projective planes.*

2.3 Topological invariants of compact surfaces.

We have not yet proved that all the cases of the classification theorem are really distinct, that is, are not homeomorphic. In order to do this we will introduce topological invariants : the Euler characteristic (or equivalently, the genus) and the orientability character.

If S is a compact surface with a triangulation $\{T_1, \dots, T_n\}$ and let v be the total number of vertices, e the total number of edges and t the total number of triangles (that is, $t = n$) then

$$\chi(S) = v - e + t$$

is called the **Euler characteristic** of S .

Leonard Euler

Born : 15 april 1707 in Basel (Switzerland)

Died : 18 september 1783 in St Petersburg (Russia)



In 1723 Euler completed his Master's degree in philosophy having compared and contrasted the philosophical ideas of Descartes and Newton. He began his study of theology in the autumn of 1723, following his father's wishes, but, although he was to be a devout Christian all his life, he could not find the enthusiasm for the study of theology, Greek and Hebrew that he found in mathematics. Euler obtained his father's consent to change to mathematics after Johann Bernoulli had used his persuasion. Euler completed his studies at the University of Basel in 1726. He had studied many mathematical works during his time in Basel, they include works by Varignon, Descartes, Newton, Galileo, von Schooten, Jacob Bernoulli, Hermann, Taylor and Wallis. By 1726 Euler had already a paper in print, a short article on isochronous curves in a resisting medium. As soon as he knew he would not be appointed to the chair of physics, Euler left Basel on 5 April 1727. He traveled down the Rhine by boat, crossed the German states by post wagon, then by boat from Lübeck arriving in St Petersburg on 17 May 1727. He had joined the St. Petersburg Academy of Science two years after it had been founded by Catherine I the wife of Peter the Great. The publication of many articles and his book *Mechanica* (1736-37), which extensively presented Newtonian dynamics in the form of mathematical analysis for the first time, started Euler on the way to major mathematical work. Euler's health problems began in 1735 when he had a severe fever and almost lost his life. By 1740 Euler had a very high reputation, having won the Grand Prize of the Paris Academy in 1738 and 1740. On both occasions he shared the first prize with others. Euler's reputation was to bring an offer to go to Berlin, but at first he preferred to remain in St Petersburg. During the twenty-five years spent in Berlin, Euler wrote around 380 articles. He wrote books on the calculus of variations; on the calculation of planetary orbits; on artillery and ballistics; on analysis; on shipbuilding and navigation; on the motion of the moon; lectures on the differential calculus; and a popular scientific publication "Letters to a Princess of Germany" (3 vols., 1768-72). In 1766 Euler returned to St Petersburg and Frederick was greatly angered at his departure. Soon after his return to Russia, Euler became almost entirely blind after an illness. In 1771 his home was destroyed by fire and he was able to save only himself and his mathematical manuscripts. A cataract operation shortly after the fire, still in 1771, restored his sight for a few days but Euler seems to have

failed to take the necessary care of himself and he became totally blind. Because of his remarkable memory was able to continue with his work on optics, algebra, and lunar motion. Amazingly after his return to St Petersburg (when Euler was 59) he produced almost half his total works despite the total blindness. After his death in 1783 the St Petersburg Academy continued to publish Euler's unpublished work for nearly 50 more years. He made decisive and formative contributions to geometry, calculus and number theory. He integrated Leibniz's differential calculus and Newton's method of fluxions into mathematical analysis. He introduced beta and gamma functions, and integrating factors for differential equations. He studied continuum mechanics, lunar theory, the three body problem, elasticity, acoustics, the wave theory of light, hydraulics, and music. He laid the foundation of analytical mechanics, especially in his "Theory of the Motions of Rigid Bodies" (1765). Analytic functions of a complex variable were investigated by Euler in a number of different contexts, including the study of orthogonal trajectories and cartography. He discovered the Cauchy-Riemann equations in 1777, although d'Alembert had discovered them in 1752. In 1755 Euler published "Institutiones calculi differentialis" which begins with a study of the calculus of finite differences. The work makes a thorough investigation of how differentiation behaves under substitutions. Euler made substantial contributions to differential geometry, investigating the theory of surfaces and curvature of surfaces. Many unpublished results by Euler in this area were rediscovered by Gauss. Other geometric investigations led him to fundamental ideas in topology such as the Euler characteristic of a polyhedron.

It is an important fact that the Euler characteristic does not depend on the given triangulation and so is really an invariant of the surface S . Using triangulations of the sphere S^2 , the torus T^2 and the projective plane compute that their Euler characters are resp. 2, 0 and 1.

Lemma 2.11 *If S_1 and S_2 are compact surfaces, then*

$$\chi(S_1 \# S_2) = \chi(S_1) + \chi(S_2) - 2$$

Proof. Take a triangulation for S_i and form their connected sum by removing from each the interior of a triangle and then identify edges and vertices of the boundaries of the removed triangles. Then, count! \square

Using this lemma it is easy to count the Euler characteristic of

- The sphere : 2.
- Connected sum of n tori : $2 - 2n$,
- Connected sum of n projective planes : $2 - n$.

Exercise 2.12 *For over 2000 years it has been known that there are only five regular polyhedra : the regular tetrahedron, cube, octahedron, dodecahedron and icosehadron.*

Prove this by considering subdivisions of the sphere into n -gons (n fixed) such that exactly m edges meet at every vertex (m fixed) with $m, n \geq 3$. Use the fact that $\chi(S^2) = 2$.

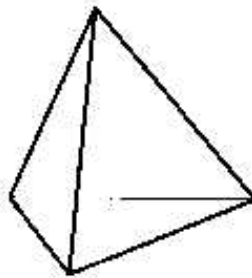

tetrahedron

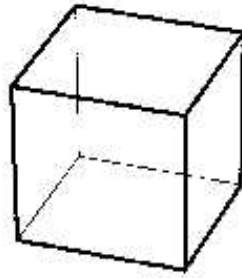

cube

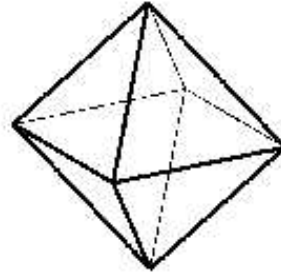

octahedron

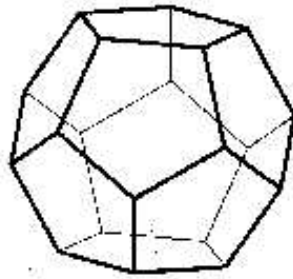

dodecahedron

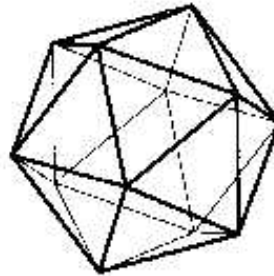

icosahedron

A surface that is the connected sum of n tori or n projective planes is said to be of **genus** n . Hence, the genus gives the number of 'holes' in the surface.

Now let us turn to orientability of (compact) surfaces. We will give a formal definition later. For now, view orientation on a manifold as a consistent way to define left or right handed coordinate systems along the surface. If the surface has a closed loop such that if one carries a right-handed coordinate system along the curve and ends up with a left handed one, then we say that the surface is not orientable.

Example 2.13 (*The Möbius strip*)

Let X be the following rectangle in the plane

$$X = \{(x, y) \in \mathbb{R}^2 \mid 0 \leq x \leq 1, 0 < y < 1\}$$

and consider the quotient space of X by identifying the vertical edges as follows

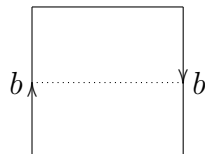

This quotient space is the Möbius strip, it is a (non-compact) connected two-dimensional manifold. The indicated closed loop is easily seen to be an orientation-reversing path, so the Möbius strip is not orientable.

As a consequence, also the projective plane is not oriented as it contains a Möbius strip as indicated below.

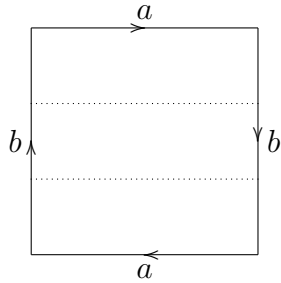

The connected sum of two orientable surfaces is again orientable. On the other hand, if either S_1 or S_2 is nonorientable, then so is $S_1 \# S_2$. As a consequence, a connected sum of tori is orientable whereas a connected sum of projective planes is not. This together with the computation of the Euler characters gives the following topological characterization of compact surfaces.

Theorem 2.14 *Let S_1 and S_2 be compact surfaces. Then, S_1 and S_2 are homeomorphic if and only if their Euler characters are equal and both are orientable or both are nonorientable.*

3 Vectorbundles

All invariants of a 3- or 4-dimensional differentiable manifold M discovered recently use special higher dimensional manifolds constructed from M . The main example of such manifolds are vectorbundles.

Definition 3.1 A (differentiable) **vectorbundle** of rank n consists of a total space E , a base M and a projection map

$$E \xrightarrow{\pi} M$$

where E and M are differentiable manifolds, each fiber

$$E_x = \pi^{-1}(x) \text{ for } x \in M$$

carries the structure of an n -dimensional (real) vector space, and the following local triviality requirement is satisfied. For each $x \in M$ there exists an open neighborhood U and a diffeomorphism

$$\pi^{-1}(U) \xrightarrow{\phi} U \times \mathbb{R}^n$$

with the property that for every $y \in U$ we have that

$$\phi_y = \phi | E_y : E_y \longrightarrow \{y\} \times \mathbb{R}^n$$

is a bijective linear map. Such a pair (ϕ, U) is called a bundle chart.

A vectorbundle may be considered as a family of n -dimensional vectorspaces parameterized by a manifold. It is important to point out that a vectorbundle is by definition locally, but not necessarily globally, a product of base and fiber. If the vectorbundle is isomorphic to $M \times \mathbb{R}^n$ we call it **trivial**.

3.1 Tangentbundle and Riemannian metrics

An important example of a vectorbundle is the tangentbundle TM having as fiber over a point $x \in M$ the tangentspace $T_x M$ in x to M .

Let (x_1, \dots, x_d) be Euclidian coordinates of \mathbb{R}^d and $\Omega \subset \mathbb{R}^d$ an open subset and $p \in \Omega$. The tangent space of Ω (or of \mathbb{R}^d) at the point p , $T_p \Omega$ is the space $\{p\} \times E$ where E is the d -dimensional vectorspace

$$E = \mathbb{R} \frac{\partial}{\partial x_1} + \dots + \mathbb{R} \frac{\partial}{\partial x_d}$$

where $\frac{\partial}{\partial x_i}$ are the partial derivatives at p .

If $\Omega' \subset \mathbb{R}^e$ is open and if we have a differentiable map

$$\Omega \xrightarrow{f} \Omega'$$

we define the derivative $df(p)$ for p as the induced linear map between the tangent spaces

$$T_p\Omega \xrightarrow{df(p)} T_{f(p)}\Omega'$$

$$v = \sum_{i=1}^d v_i \frac{\partial}{\partial x_i} \mapsto \sum_{i=1}^d \sum_{j=1}^e v_i \frac{\partial f_j}{\partial x_i}(p) \frac{\partial}{\partial f_j}$$

With the previous notations we put

$$T\Omega = \Omega \times E \simeq \Omega \times \mathbb{R}^d$$

which is an open subset of $\mathbb{R}^d \times \mathbb{R}^d$ and hence a differentiable manifold. Projection on the first factor

$$T\Omega \xrightarrow{\pi} \Omega \text{ where } (x, v) \mapsto x$$

makes $T\Omega$ into a vectorbundle called the tangentbundle of Ω . Likewise we define

$$T\Omega \xrightarrow{df} T\Omega'$$

by the assignment

$$(x, \sum_{i=1}^d v_i \frac{\partial}{\partial x_i}) \mapsto (f(x), \sum_{i=1}^d \sum_{j=1}^e v_i \frac{\partial f_j}{\partial x_i}(x) \frac{\partial}{\partial f_j})$$

We will now generalize the construction to a differentiable manifold M of dimension d and $p \in M$. Let (ϕ, U) be a chart of M with $p \in U$. Clearly we would like to define the tangent space T_pM of M in p to be

$$T_pM = T_{\phi(p)}\phi(U).$$

Then, T_pM is a vectorspace of dimension d hence isomorphic to \mathbb{R}^d . This isomorphism, however, is not canonical, but depends on the choice of chart. Hence, let (ϕ', U') be another chart with $p \in U'$. The diffeomorphic transition map

$$\phi(U \cap U') \xrightarrow{\phi' \circ \phi^{-1}} \phi'(U \cap U')$$

induces a vector space isomorphism

$$L = d(\phi' \circ \phi^{-1})(\phi(p)) : T_{\phi(p)}\Omega \longrightarrow T_{\phi'(p)}\Omega'$$

(where $\Omega = \phi(U)$ and $\Omega' = \phi'(U')$) and we say that $v \in T_{\phi(p)}\Omega$ and $L(v) \in T_{\phi'(p)}\Omega'$ represent the same tangent vector in T_pM . That is, a tangent vector is given by the family of its coordinate representations. Formally,

Definition 3.2 Let $p \in M$. We define an equivalence relation on

$$\{(\phi, v) \mid (\phi, U) \text{ a chart with } p \in U, v \in T_{\phi(p)}\phi(U)\}$$

defined by

$$(\phi, v) \cong (\psi, w) \Leftrightarrow w = d(\psi \circ \phi^{-1})v$$

The space of equivalence classes is called the **tangent space** to M at the point p and it is denoted by T_pM . Clearly, T_pM is a vectorspace where the equivalence class of $\lambda(\phi, v) + \mu(\phi, w)$ is that of $(\phi, \lambda v + \mu w)$.

Observe that for a differentiable map $M \xrightarrow{F} N$ between differentiable manifolds, dF is represented in local charts (ϕ, U) of M and (ψ, V) of N by $d(\psi \circ F \circ \phi^{-1})$ and it induces linear maps for all $p \in M$

$$T_pM \xrightarrow{dF} T_{F(p)}N$$

The disjoint union TM of the tangent spaces T_pM for $p \in M$ is made into a differentiable manifold as follows. If (ϕ, U) is a chart for M we let TU be the disjoint union of the T_pM with $p \in U$ and define the chart

$$TU \xrightarrow{d\phi} T\phi(U)$$

where $T\phi(U)$ carries the differentiable structure of $\phi(U) \times \mathbb{R}^d$ and it is easy to verify that the transition maps

$$d\psi \circ d\phi^{-1} = d(\psi \circ \phi^{-1})$$

then all are differentiable. We also have a natural projection map $TM \xrightarrow{\pi} M$ defined by $\pi(v) = p$ for all $v \in T_pM$.

Definition 3.3 The triple (TM, π, M) is called the **tangentbundle** of M and TM is called the **total space of the tangentbundle**.

Exercise 3.4 Prove the following alternative definition of a tangentspace which is more elegant but less easy to compute with.

A **germ** of a function at $p \in M$ is an equivalence class of smooth functions defined on neighborhoods of p , where two such functions are equivalent if they coincide on some neighborhood of p . A tangent vector at p may then be defined as a linear operator δ on the function germs at p satisfying the Leibniz rule

$$\delta(f.g)(x) = (\delta f(x))f(x) + f(x)(\delta g(x))$$

We want to introduce metric structures on differentiable manifolds, in particular we want to define the length of tangent vectors. Then, by integration we can define the length of a differentiable curve and hence 'geodesics' as curves of minimal length.

Definition 3.5 *A Riemannian metric on a differentiable manifold M is given by a scalar product on each tangent space T_pM which depends smoothly on the point p . A **Riemannian manifold** is a differentiable manifold equipped with a Riemannian metric.*

Georg Friedrich Bernhard Riemann

Born : 17 september 1826 in Hanover (Germany)

Died : 20 july 1866 in Selasca (Italy)



In 1849 he returned to Göttingen and his Ph.D. thesis, supervised by Gauss, was submitted in 1851. However it was not only Gauss who strongly influenced Riemann at this time. Weber had returned to a chair of physics at Göttingen from Leipzig during the time that Riemann was in Berlin, and Riemann was his assistant for 18 months. Also Listing had been appointed as a professor of physics in Göttingen in 1849. Through Weber and Listing, Riemann gained a strong background in theoretical physics and, from Listing, important ideas in topology which were to influence his ground breaking research. Riemann's thesis studied the theory of complex variables and, in particular, what we now call Riemann surfaces. It therefore introduced topological methods into complex function theory. The work builds on Cauchy's foundations of the theory of complex variables built up over many years and also on Puiseux's ideas of branch points. However, Riemann's thesis is a strikingly original piece of work which examined geometric properties of analytic functions, conformal mappings and the connectivity of surfaces. On Gauss's recommendation Riemann was appointed to a post in Göttingen and he worked for his Habilitation, the degree which would allow him to become a lecturer. He spent thirty months working on his Habilitation dissertation which was on the representability of functions by trigonometric series. He gave the conditions of a function to have an integral, what we now call the condition of Riemann integrability. To complete his Habilitation Riemann had to give a lecture. He prepared three lectures, two on electricity and one on geometry. Gauss had to choose one of the three for Riemann to deliver and, against Riemann's expectations, Gauss chose the lecture on geometry. Riemann's lecture "Über die Hypothesen welche der Geometrie zu Grunde liegen" delivered on 10 June 1854, became a classic of mathematics. There were two

parts to Riemann's lecture. In the first part he posed the problem of how to define an n -dimensional space and ended up giving a definition of what today we call a Riemannian manifold. In fact the main point of this part of Riemann's lecture was the definition of the curvature tensor. The second part of Riemann's lecture posed deep questions about the relationship of geometry to the world we live in. He asked what the dimension of real space was and what geometry described real space. The lecture was too far ahead of its time to be appreciated by most scientists of that time. In 1858 Betti, Casorati and Brioschi visited Göttingen and Riemann discussed with them his ideas in topology. This gave Riemann particular pleasure and perhaps Betti in particular profited from his contacts with Riemann. The winter of 1862-63 was spent in Sicily and he then traveled through Italy, spending time with Betti and other Italian mathematicians who had visited Göttingen. He returned to Göttingen in June 1863 but his health soon deteriorated and once again he returned to Italy. Having spent from August 1864 to October 1865 in northern Italy, Riemann returned to Göttingen for the winter of 1865-66, then returned to Selasca on the shores of Lake Maggiore on 16 June 1866. He died 4 days later.

The simplest example of a Riemannian metric is of course the Euclidian one. For $v = (v_1, \dots, v_d)$ and $w = (w_1, \dots, w_d) \in T_x \mathbb{R}^d$, the Euclidian scalar product is

$$\langle v, w \rangle = \sum_{i=1}^d v_i w_i$$

and is hence determined by the positive definite symmetric matrix

$$(\delta_{ij})_{i,j}$$

where δ_{ij} is the Kronecker symbol.

Consider an open set U around $p \in M$ and let $x = (x_1, \dots, x_d)$ be the local coordinates, then we require a positive definite symmetric matrix

$$(g_{ij}(x))_{i,j}$$

that is, $g_{ij}(x) = g_{ji}(x)$ for all i, j , for all $(\zeta_1, \dots, \zeta_d) \neq 0 \in \mathbb{R}^d$ we have

$$\sum_{i,j=1}^d g_{ij}(x) \zeta_i \zeta_j > 0$$

and the coefficients $g_{ij}(x)$ depend smoothly on x .

We can then define an inproduct on tangent vectors $v, w \in T_p M$ by the rule

$$\langle v, w \rangle = \sum_{i,j=1}^d g_{ij}(x(p)) v_i w_j$$

where $v = \sum v_i \frac{\partial}{\partial x_i}$ and $w = \sum w_i \frac{\partial}{\partial x_i}$. The length of a tangent vector $v \in T_p M$ is then defined as

$$\|v\| = \sqrt{\langle v, v \rangle}$$

Exercise 3.6 Compute that if $f(x)$ define other local coordinates and if the metric in these new coordinates is given by $h_{kl}(f(x))$ then we have

$$\sum_{k,l=1}^d h_{kl}(f(x)) \frac{\partial f_k}{\partial x_i} \frac{\partial f_l}{\partial x_j} = g_{ij}(x)$$

In particular, the smoothness of the metric does not depend on the choice of local coordinates.

We will see below that a connected paracompact differentiable manifold always has a Riemannian metric (but observe that there are more such metrics). Recall that a topological space is called **paracompact** if any open covering has a locally finite refinement. Observe that this condition is also necessary as we will see below that a Riemannian manifold is a metric space and hence paracompact.

First we need an multitude of C^∞ functions on a differentiable manifold.

Lemma 3.7 Let $0 < b < c \in \mathbb{R}$. Then there exists a C^∞ -function $\mathbb{R} \xrightarrow{f} \mathbb{R}$ with

$$\begin{aligned} f(t) &= 0 & \text{for } t &\leq b \\ 0 \leq f(t) &\leq 1 & \text{for all } t \\ f(t) &= 1 & \text{for } t &\geq c \end{aligned}$$

Proof. Let $g(x)$ be the C^∞ -function which is zero if $x \leq 0$ and is e^{-1/x^2} for $x > 0$. Consider

$$h(x) = g\left(x + \frac{c-b}{2}\right)g\left(-x - \frac{c-b}{2}\right)$$

And consider the function

$$i(x) = \frac{\int_{-\infty}^x h(y)dy}{\int_{-\infty}^{\infty} h(y)dy}$$

Then $f(x) = i(x - \frac{c+b}{2})$ has the required properties. \square

Lemma 3.8 Let $0 < b < c \in \mathbb{R}$, then there is a C^∞ -function $\mathbb{R}^d \xrightarrow{F} \mathbb{R}$ with

$$\begin{aligned} F(p) &= 0 & \text{for } \|p\| &\leq b \\ 0 \leq F(p) &\leq 1 & \text{for all } p \\ F(p) &= 1 & \text{for } \|p\| &\geq c \end{aligned}$$

Proof. Take $F(p) = f(\|p\|)$ with f as above. \square

Lemma 3.9 *Let M be a differentiable d -dimensional manifold, $p \in M$. Then there is a neighborhood V of p and a C^∞ -function $M \xrightarrow{f} \mathbb{R}$ such that $f(x) \geq 0$ for $x \in V$ and $f(x) = 0$ for $x \notin V$.*

Proof. Let (ϕ, U) be a chart containing p and assume without loss of generality that $\phi(p) = (0, \dots, 0) \in \mathbb{R}^d$. Choose numbers $0 < b < c$ such that the open ball with radius c $B(0, c)$ is contained in $\phi(U)$. Let $G = 1 - F$ with F as before and take $V = \phi^{-1}(B(0, c))$ and let $f = G \circ \phi$ on V and $f(x) = 0$ for $x \notin V$. \square

It is about time to do something useful with these lemmas.

Proposition 3.10 *(partition of unity)*

If M is a paracompact differentiable manifold, then there is a locally finite atlas (ϕ_i, U_i) and a collection g_i of non-negative real valued C^∞ -functions such that $g_i(x) = 0$ for $x \notin U_i$ and

$$\sum_i g_i = 1$$

Proof. From paracompactness and the foregoing lemma we obtain a locally finite atlas (ϕ_i, U_i) with C^∞ -functions $M \xrightarrow{f_i} \mathbb{R}$ such that $f_i > 0$ on U_i and $f_i = 0$ on $M - U_i$. The function $F = \sum_i f_i$ is a well-defined non-vanishing C^∞ -function on M and take $g_i = f_i/F$. \square

Theorem 3.11 *Every paracompact differentiable manifold may be equipped with a Riemannian metric.*

Proof. Let (ϕ_i, U_i) and g_i be as above. Let $v, w \in T_p M$ with representations (if $p \in U_i$) $(v(i)_1, \dots, v(i)_d)$ resp. $(w(i)_1, \dots, w(i)_d)$. Then, define

$$\langle v, w \rangle = \sum_{i|p \in U_i} \sum_{j=1}^d g_i(p) v(i)_j w(i)_j$$

which is well defined and a Riemannian metric. \square

If $[a, b]$ is a closed interval in \mathbb{R} and we have a smooth (that is, C^∞) curve

$$[a, b] \xrightarrow{\gamma} M$$

then we define the **length** of γ using the Riemannian metric to be

$$L(\gamma) = \int_a^b \left\| \frac{d\gamma}{dt}(t) \right\| dt$$

and the **energy** of γ to be the integral

$$E(\gamma) = \frac{1}{2} \int_a^b \left\| \frac{d\gamma}{dt}(t) \right\|^2 dt$$

Of course, these expressions can be computed in local coordinates. If $\gamma(t) = (x_1(\gamma(t)), \dots, x_d(\gamma(t)))$ and we use the abbreviation $\dot{x}_i(t) = \frac{d}{dt}(x_i(\gamma(t)))$ then e.g. the energy becomes

$$E(\gamma) = \frac{1}{2} \int_a^b \sum_{i,j=1}^d g_{ij}(x(\gamma(t))) \dot{x}_i(t) \dot{x}_j(t) dt$$

A recurring theme in differential geometry will be that once we have a functional on geometric objects (here, curves) we want to describe the objects having critical values. These are described via **Euler-Lagrange equations**. Recall that if we have a functional of the form

$$I(x) = \int_a^b f(t, x(t), \dot{x}(t)) dt$$

then its Euler-Lagrange equations are given by

$$\frac{d}{dt} \frac{\partial f}{\partial \dot{x}_i} - \frac{\partial f}{\partial x_i} = 0 \text{ for all } 1 \leq i \leq d$$

If we define the inverse of the matrix $(g_{ij}(x))_{i,j}$ to be $(g^{ij}(x))_{i,j}$, then we obtain

Proposition 3.12 *The Euler-Lagrange equations for the energy E are*

$$\ddot{x}_i(t) + \sum_{j,k=1}^d \Gamma_{jk}^i(x(t)) \dot{x}_j(t) \dot{x}_k(t) = 0$$

for $1 \leq i \leq d$ with the **Christoffel symbols**

$$\Gamma_{jk}^i = \frac{1}{2} \sum_{l=1}^d g^{il} (g_{jl,k} + g_{kl,j} - g_{jk,l})$$

where we define

$$g_{jl,k} = \frac{\partial}{\partial x_k} g_{jl}$$

Proof. Writing down the Euler-Lagrange equations in local coordinates we obtain for $1 \leq i \leq d$

$$\frac{d}{dt} \left(\sum_k g_{ik}(x(t)) \dot{x}_k(t) + \sum_j g_{ji}(x(t)) \dot{x}_j(t) \right) - \sum_{j,k} g_{jk,i}(x(t)) \dot{x}_j(t) \dot{x}_k(t) = 0$$

whence

$$\sum_{j,k,l} g_{ik} \ddot{x}_k + g_{ji} \ddot{x}_j + g_{ik,l} \dot{x}_l \dot{x}_k + g_{ji,l} \dot{x}_l \dot{x}_j - g_{jk,i} \dot{x}_j \dot{x}_k = 0$$

Renaming some indices and using the symmetry $g_{ik} = g_{ki}$ we get for $1 \leq l \leq d$

$$\sum_{j,k,m} 2g_{lm} \ddot{x}_m + (g_{lk,j} + g_{jl,k} - g_{jk,l}) \dot{x}_j \dot{x}_k = 0$$

multiplying this with $\sum_l g^{il}$ and using $\sum_l g^{il} g_{lm} = \delta_{im}$ we obtain the required equations. \square

Elwin Bruno Christoffel

Born : 10 november in Monschau (Germany)

Died : 15 march 1900 in Strasbourg (France)



Elwin Christoffel was noted for his work in mathematical analysis, in which he was a follower of Dirichlet and Riemann. Christoffel studied at the University of Berlin from 1850 where he was taught by Borchardt, Eisenstein, Joachimsthal, Steiner and Dirichlet. It was Dirichlet who had the greatest influence on him and Christoffel is rightly thought of as a student of Dirichlet's. Christoffel published papers on function theory including conformal mappings, geometry and tensor analysis, Riemann's α -function, the theory of invariants, orthogonal polynomials and continued fractions, differential equations and potential theory, light, and shock waves. Some of Christoffel's early work was on conformal mappings of a simply connected region bounded by polygons onto a circle. This work on conformal mappings was published in four papers between 1868 and 1870. The first of these papers was written while Christoffel was at Zurich, the remaining three papers on the Christoffel-Schwarz formula were written while he was at the Gewerbsakademie in Berlin. Between 1865 and 1871 Christoffel published four important papers on potential theory, three of them dealing with the Dirichlet problem. Christoffel was interested in the theory of invariants. He wrote six papers on this topic. He wrote

important papers which contributed to the development of the tensor calculus of C G Ricci-Curbastro and Tullio Levi-Civita. The Christoffel symbols Γ_{jk}^i which he introduced are fundamental in the study of tensor analysis. The Christoffel reduction theorem, so named by Klein, solves the local equivalence problem for two quadratic differential forms. His influence is clearly seen since this allowed Ricci-Curbastro and Levi-Civita to develop a coordinate free differential calculus which Einstein, with the help of Grossmann, turned into the tensor analysis mathematical foundation of general relativity.

Definition 3.13 *A smooth curve $\gamma : [a, b] \longrightarrow M$ which satisfies*

$$\ddot{x}_i(t) + \sum_{j,k=1}^d \Gamma_{jk}^i(x(t)) \dot{x}_j(t) \dot{x}_k(t) = 0$$

for $1 \leq i \leq d$ is called a **geodesic**.

One can show that geodesics with minimal energy also minimize the length. Hence, one can use geodesics to make a Riemannian manifold M into a metric space by defining the **distance** between two points $p, q \in M$ to be

$$d(p, q) = \inf\{L(\gamma) \mid \gamma : [a, b] \longrightarrow M \text{ piecewise smooth with } \gamma(a) = p, \gamma(b) = q\}$$

and using connectivity of M one can show that this function is always defined. One can show that this distance function satisfies all the requirements of a metric and that the topology on M induced by this distance function coincides with the original manifold topology of M . Finally observe that geodesics are important in physics as particles have the tendency to move along paths minimizing their energy.

3.2 Vectorfields, forms and tensors.

In this subsection we will recall some standard definitions and constructions of vectorbundles taking the tangentbundle TM as a basic example.

Definition 3.14 *Let (E, π, M) be a vectorbundle. A **section** of E is a differentiable map*

$$E \xrightarrow{s} M$$

with $\pi \circ s = id_M$. The space of sections of E is denoted by $\Gamma(E)$.

A section of the tangentbundle TM is called a **vectorfield** on M . It assigns to each point p a tangentvector to M at p in a smooth way.

We can generalize most constructions from vector spaces to vectorbundles by performing them fiberwise.

Definition 3.15 Let (E_1, π_1, M) and (E_2, π_2, M) be vectorbundles over M . A differentiable map

$$E_1 \xrightarrow{f} E_2$$

is called a bundle homomorphism if f is fibre preserving, that is, if $\pi_2 \circ f = \pi_1$ and the fiber maps

$$E_{1,p} \xrightarrow{f_p} E_{2,p}$$

are linear.

Definition 3.16 Let (E, π, M) be a vectorbundle of rank n and $E' \subset E$. $(E', \pi|_{E'}, M)$ is a **subbundle** of E if for every $p \in M$ there is a bundle chart (ϕ, U) of E with $p \in U$ such that

$$\phi(\pi^{-1}(U) \cap E') = U \times \mathbb{R}^m \subset U \times \mathbb{R}^n$$

Definition 3.17 Let (E_1, π_1, M) and (E_2, π_2, M) be vectorbundles over M . One can construct the following vectorbundles :

1. The tensor productbundle $(E_1 \otimes E_2, \pi_1 \otimes \pi_2, M)$ having as fibers $E_{1,p} \otimes E_{2,p}$. Recall that if V and W are vectorspaces of dimension m and n with basis $\{v_1, \dots, v_m\}$ resp. $\{w_1, \dots, w_n\}$, then $V \otimes W$ is the vector space of dimension mn spanned by the basis $\{v_i \otimes w_j \mid 1 \leq i \leq m, 1 \leq j \leq n\}$.
2. The dual bundle (E_i^*, π^*, M) having as fibers the dual space $E_{i,p}^*$. Recall that if V is a vector space of dimension m with basis $\{v_1, \dots, v_m\}$, then V^* is the vector space of dimension m spanned by the linear maps $\{f_1, \dots, f_m\}$ where $f_i : V \longrightarrow \mathbb{R}$ satisfy $f_i(v_j) = \delta_{ij}$.

In particular, the dual bundle of TM is denoted with T^*M and is called the **cotangentbundle** of M . Sections of T^*M are called **1-forms** on M .

If in local coordinates $T_p M$ has basevectors $\frac{\partial}{\partial x_i}$, then $T_p^* M$ has basevectors dx_i .

If f is a coordinate change, then a tangentvector $v = \sum_i v_i \frac{\partial}{\partial x_i}$ is transformed to

$$f_*(v) = \sum_{i,j} v_i \frac{\partial f_j}{\partial x_i} \frac{\partial}{\partial f_j}$$

whereas a cotangentvector $\eta = \sum \eta_i dx_i$ is transformed to

$$f^*(\eta) = \sum_{i,j} \eta_i \frac{\partial x_i}{\partial f_j} df_j$$

because in this case we have

$$f^*(\eta) f_*(v) = \sum_{i,j,k} \eta_j \frac{\partial x_j}{\partial f_k} v_i \frac{\partial f_k}{\partial x_i} = \sum_i \eta_i v_i = \eta(v)$$

Definition 3.18 A p times contravariant and q times covariant tensor field on M is a section of the vectorbundle

$$\underbrace{TM \otimes \dots \otimes TM}_p \otimes \underbrace{T^*M \otimes \dots \otimes T^*M}_q$$

Under a coordinate change f such a tensor field is transformed p times by the matrix (df) and q times by the matrix $(df^{-1})^\tau$.

For example, A Riemannian metric is a two times covariant tensorfield on M which is symmetric and positive definite, hence a section of $T^*M \otimes T^*M$ and we can therefore write the metric in local coordinates as

$$\sum_{i,j} g_{ij}(x) dx_i \otimes dx_j$$

Recall that if V is an m -dimensional vectorspace with basis $\{v_1, \dots, v_m\}$ then the p -th **exterior product** of V

$$\wedge^p V = \underbrace{V \wedge \dots \wedge V}_p$$

is the subvectorspace of $\otimes_{i=1}^p V$ consisting of anti-symmetric tensors. That is, if $\sigma \in S_p$ the symmetric group on p letters then σ acts on $\otimes_{i=1}^p V$ via

$$\sigma(u_1 \otimes u_2 \otimes \dots \otimes u_m) = u_{\sigma(1)} \otimes u_{\sigma(2)} \otimes \dots \otimes u_{\sigma(m)}$$

and a p -tensor $w \in \otimes_{i=1}^p V$ is said to be anti-symmetric if $\sigma(w) = \text{sgn}(\sigma)w$ where $\text{sgn}(w) = \pm 1$ the sign of the permutation. One can show that a basis of $\wedge^p V$ is given by the tensors

$$v_{i_1} \wedge v_{i_2} \wedge \dots \wedge v_{i_p}$$

for all $1 \leq i_1 < i_2 < \dots < i_p \leq m$ where this expression stands for the p -tensor

$$\sum_{\sigma \in S_p} \text{sgn}(\sigma) v_{\sigma(i_1)} \otimes \dots \otimes v_{\sigma(i_p)}$$

Therefore, the dimension of the vectorspace $\wedge^p V$ is $\binom{m}{p}$.

The vectorbundle over M with fibres $\wedge^p T_p^*M$ will be denoted by $\wedge^p(M)$. The space of its sections will be denoted as

$$\Gamma(\wedge^p(M)) = \Omega^p(M)$$

and its elements are called **p -forms** on M . In local coordinates a p -form is a sum of terms of the form

$$\omega(x) = \eta(x) dx_{i_1} \wedge \dots \wedge dx_{i_p}$$

Thus, a p -form assigns to each point $p \in M$ an alternating p -linear map

$$\omega_p : T_p M \times \dots \times T_p M \longrightarrow \mathbb{R}$$

We have two important operations on $\wedge^p T_p^* M$. For any $\eta \in T_p^* M$ there is a map

$$\wedge^p T_p^* M \xrightarrow{\epsilon(\eta)} \wedge^{p+1} T_p^* M$$

determined by $\epsilon(\eta)(\omega) = \eta \wedge \omega$. On the other hand, for any tangent vector $v \in T_p M$ we have a map

$$\wedge^p T_p^* M \xrightarrow{i(v)} \wedge^{p-1} T_p^* M$$

determined by

$$i(v)(\omega)(v_1, \dots, v_{p-1}) = \omega(v, v_1, \dots, v_{p-1})$$

for all $v_i \in T_p M$.

Definition 3.19 *The exterior derivative*

$$\Omega^p(M) \xrightarrow{d} \Omega^{p+1}(M)$$

is defined by linearly extending the formula

$$d(\eta(x) dx_{i_1} \wedge \dots \wedge dx_{i_p}) = \sum_{j=1}^d \frac{\partial \eta(x)}{\partial x_j} dx_j \wedge dx_{i_1} \wedge \dots \wedge dx_{i_p}$$

Exercise 3.20 *Prove that for $\omega \in \Omega^p(M)$ and $\theta \in \Omega^q(M)$ we have*

$$d(\omega \wedge \theta) = d(\omega) \wedge \theta + (-1)^{pq} \omega \wedge d(\theta)$$

Moreover, show that

$$d \circ d = 0$$

If $M \xrightarrow{f} N$ is a differentiable map and

$$\omega(z) = \eta(z) dz_{i_1} \wedge \dots \wedge dz_{i_p} \in \Omega^p(N)$$

is a p -form on N , then we can pull it back to a p -form on M by the rule

$$f^*(\omega)(x) = \sum_{j_1, \dots, j_p} \eta(f(x)) \frac{\partial f_{i_1}}{\partial x_{j_1}} dx_{j_1} \wedge \dots \wedge \frac{\partial f_{i_p}}{\partial x_{j_p}} dx_{j_p}$$

Exercise 3.21 *Show that the pull back is compatible with exterior derivative*

$$d(f^*(\omega)) = f^*(d(\omega))$$

When applied to a coordinate transformation f this shows in particular that the definition of d is independent of the choice of local coordinates.

Georges de Rham

Born : 10 september 1903 in Roche (Switzerland)

Died : 9 october 1990 in Lausanne (Switzerland)



From 1926 he studied in Paris for his doctorate, spending the winter term of 1930/31 at the University of Göttingen. He was awarded his doctorate from Paris in 1931 and became a lecturer at the University of Lausanne. There he was promoted to extraordinary professor in 1936 and to full professor in 1943. He retired and was given an honorary appointment by Lausanne in 1971. Raoul Bott describes the context of de Rham's famous theorem:- "In some sense the famous theorem that bears his name dominated his mathematical life, as indeed it dominates so much of the mathematical life of this whole century. When I met de Rham in 1949 at the Institute in Princeton he was lecturing on the Hodge theory in the context of his 'currents'. These are the natural extensions to manifolds of the distributions which had been introduced a few years earlier by Laurent Schwartz and of course it is only in this extended setting that both the de Rham theorem and the Hodge theory become especially complete. The original theorem of de Rham was most probably believed to be true by Poincaré and was certainly conjectured (and even used!) in 1928 by E Cartan. But in 1931 de Rham set out to give a rigorous proof. The technical problems were considerable at the time, as both the general theory of manifolds and the 'singular theory' were in their early formative stages."

3.3 de Rham cohomology

Let M be a differential manifold of dimension d , then we have a complex

$$\begin{aligned} 0 &\longrightarrow \Omega^0(M) \xrightarrow{d} \Omega^1(M) \xrightarrow{d} \dots \\ \dots &\xrightarrow{d} \Omega^p(M) \xrightarrow{d} \Omega^{p+1}(M) \xrightarrow{d} \dots \\ &\dots \xrightarrow{d} \Omega^d(M) \xrightarrow{d} 0 \end{aligned}$$

satisfying $d \circ d = 0$. A p -form $\alpha \in \Omega^p(M)$ is said to be **closed** if $d\alpha = 0$ and is said to be **exact** if there exists $\eta \in \Omega^{p-1}(M)$ such that $d\eta = \alpha$.

On the closed forms one defines an equivalence relation by calling two forms $\alpha, \beta \in \Omega^p(M)$ cohomologous if $\alpha - \beta$ is exact.

Definition 3.22 *The set of equivalence classes of closed forms in $\Omega^p(M)$ is a vector space over \mathbb{R} called the p -th **de Rham cohomology group** and denoted by*

$$H_{dR}^p(M, \mathbb{R}) \text{ or, usually, } H^p(M)$$

Therefore,

$$H_{dR}^p(M, \mathbb{R}) = \frac{\text{Ker } \Omega^p(M) \xrightarrow{d} \Omega^{p+1}(M)}{\text{Im } \Omega^{p-1}(M) \xrightarrow{d} \Omega^p(M)}$$

One can show that for a compact differentiable manifold, all cohomology groups $H_{dR}^p(M, \mathbb{R})$ are finite-dimensional vectorspaces. The dimension

$$b_p(M) = \dim H_{dR}^p(M, \mathbb{R})$$

is called the p -th **Betti number** of M and is an important numerical invariant of the manifold M .

Enrico Betti

Born : 21 october 1823 in Pistoia (Italy)

Died : 11 august 1892 in Pisa (Italy)



Enrico Betti is noted for his contributions to algebra and topology. Betti studied at the University of Pisa, later was to become a professor (1857) and rector there and director of its teacher's college. Under his leadership the Scuola Normale Superiore in Pisa became the leading Italian center for mathematical research and mathematical

education. Betti is noted for his contributions to algebra and topology. His early work is in the area of equations and algebra. Betti extended and gave proofs relating to the algebraic concepts of Evariste Galois. These had been previously given without proofs. Betti thus made an important contribution to the transition from classical to modern algebra. He published this in several works starting in 1851. He was the first to give a proof that the Galois group is closed under multiplication. In 1854 Betti showed that the quintic equation could be solved in terms of integrals resulting in elliptic functions. Bernhard Riemann arrived in Pisa in 1863. Influenced by his friend Bernhard Riemann, Betti did important work in theoretical physics, in particular in potential theory and elasticity. Riemann inspired Betti's memoir on topology which Betti had neglected for 40 years.

Before we can define extra structure on these cohomology groups, we have to recall some facts from linear algebra.

Let V be a real vectorspace of dimension d equipped with an inproduct $\langle \cdot, \cdot \rangle$ and let $\wedge^p V$ be the p -th exterior product of V . We then obtain an inproduct on $\wedge^p V$ by the rule

$$\langle v_1 \wedge \dots \wedge v_p, w_1 \wedge \dots \wedge w_p \rangle = \det (\langle v_i, w_j \rangle)_{i,j}$$

and extend this bilinearly to $\wedge^p V$.

Thus, if e_1, \dots, e_d is an orthogonal basis of V , then

$$e_{i_1} \wedge \dots \wedge e_{i_p} \text{ with } 1 \leq i_1 < i_2 < \dots < i_p \leq d$$

is an orthogonal basis for $\wedge^p V$.

An **orientation** on V is the choice of a distinguished basis of V . Any other basis that is obtained from this basis by a basechange with positive determinant is called positive, and the other bases are called negative.

If we give V an orientation, we can define the linear **star operator**

$$\wedge^p V \xrightarrow{*} \wedge^{d-p} V$$

by defining for all $0 \leq p \leq d$

$$*(e_{i_1} \wedge \dots \wedge e_{i_p}) = e_{j_1} \wedge \dots \wedge e_{j_{d-p}}$$

where j_1, \dots, j_{d-p} is selected such that

$$\{e_{i_1}, \dots, e_{i_p}, e_{j_1}, \dots, e_{j_{d-p}}\}$$

is a positive basis of V .

For example we have if e_1, \dots, e_d is a positive basis of V that

$$*(1) = e_1 \wedge \dots \wedge e_d$$

$$*(e_1 \wedge \dots \wedge e_d) = 1$$

Lemma 3.23 *We have that $** = (-1)^{p(d-p)}$ on $\wedge^p V$.*

Proof. By definition we know that

$$** (e_{i_1} \wedge \dots \wedge e_{i_p}) = \pm e_{i_1} \wedge \dots \wedge e_{i_p}$$

depending on whether or not $e_{j_1}, \dots, e_{j_{d-p}}, e_{i_1}, \dots, e_{i_p}$ is a positive basis of V where $e_{j_1} \wedge \dots \wedge e_{j_{d-p}}$ is the $*$ $(e_{i_1} \wedge \dots \wedge e_{i_p})$. Observe that

$$\begin{aligned} (-1)^{p(d-p)} e_{j_1} \wedge \dots \wedge e_{j_{d-p}} \wedge e_{i_1} \wedge \dots \wedge e_{i_p} = \\ e_{i_1} \wedge \dots \wedge e_{i_p} \wedge e_{j_1} \wedge \dots \wedge e_{j_{d-p}} \end{aligned}$$

□

Exercise 3.24 Show that for all $v, w \in \wedge^p V$ we have

$$\langle v, w \rangle = *(w \wedge *v) = *(v \wedge *w)$$

Hint : verify it on wedges of an orthonormal basis of V .

If $\{v_1, \dots, v_d\}$ is an arbitrary positive basis of V show that

$$*(1) = \frac{1}{\sqrt{\det (\langle v_i, v_j \rangle)_{i,j}}} v_1 \wedge \dots \wedge v_d$$

A manifold M is said to be **oriented** if we may select an orientation on all the tangent spaces $T_p M$ in a consistent manner (see later for a formal definition in terms of structure groups of vectorbundles).

We now suppose that M is a compact oriented Riemannian manifold of dimension d . Because of the Riemannian structure we have an inner product on each $T_p^* M$ given by $(g^{ij}(x)) = (g_{ij}(x))^{-1}$. By the orientability of M we have a consistent choice of orientation on all the cotangent spaces $T_p^* M$. Therefore, we have a star operation

$$\wedge^p(T_p^* M) \xrightarrow{*} \wedge^{d-p}(T_p^* M)$$

and we have in local coordinates

$$*(1) = \sqrt{\det(g_{ij})} dx_1 \wedge \dots \wedge dx_d$$

which is called the **volume form** on M .

Hence, we have a star operation on the sections

$$\Omega^p(M) \xrightarrow{*} \Omega^{d-p}(M)$$

On $\Omega^p(M)$ we can define a bilinear and positive definite form by taking for $\alpha, \beta \in \Omega^p(M)$

$$\langle \alpha, \beta \rangle = \int_M \langle \alpha, \beta \rangle *(1) = \int_M \alpha \wedge *(\beta)$$

This form allows us to define operators

$$\Omega^p(M) \xrightarrow{\delta} \Omega^{p-1}(M)$$

by declaring that it should be formally adjoint to the exterior derivative d . That is, we require for all $\alpha \in \Omega^{p-1}(M)$ and $\beta \in \Omega^p(M)$ that

$$(d\alpha, \beta) = (\alpha, \delta\beta)$$

Pierre-Simon Laplace

Born : 28 march 1749 in Beaumont-en-Auge (France)

Died : 5 march 1825 in Paris (France)



Pierre-Simon Laplace proved the stability of the solar system. In analysis Laplace introduced the potential function and Laplace coefficients. He also put the theory of mathematical probability on a sound footing. Laplace attended a Benedictine priory school in Beaumont between the ages of 7 and 16. At the age of 16 he entered Caen University intending to study theology. Laplace wrote his first mathematics paper while at Caen. At the age of 19, mainly through the influence of d'Alembert, Laplace was appointed to a chair of mathematics at the Ecole Militaire in Paris on the recommendation of d'Alembert. In 1773 he became a member of the Paris Academy of Sciences. In 1785, as examiner at the Royal Artillery Corps, he examined and passed the 16 year old Napoleon Bonaparte. Laplace became Count of the Empire in 1806 and he was named a marquis in 1817 after the restoration of the Bourbons. In his later years he lived in Arcueil, where he helped to found the Societe d'Arcueil and encouraged the research of young scientists. Laplace discovered the invariability of planetary mean motions. In 1786 he proved that the eccentricities and inclinations of planetary orbits to each other always remain small, constant, and self-correcting. These results appear in his greatest work, "Traité du Mécanique Céleste" published in 5 volumes over 26 years (1799-1825). Laplace also worked on probability and in particular derived the least squares rule. He also worked on differential equations and geodesy. In analysis Laplace introduced the potential function and Laplace coefficients. He also put the theory of mathematical probability on a sound footing. With Antoine Lavoisier he conducted experiments on capillary action and specific heat. He also contributed to the foundations of the mathematical science of electricity and magnetism.

Definition 3.25 *The Laplace-Beltrami operator on $\Omega^p(M)$ is defined to be*

$$\Delta = d\delta + \delta d : \Omega^p(M) \longrightarrow \Omega^p(M)$$

*A p -form $\omega \in \Omega^p(M)$ is called **harmonic** provided that $\Delta(\omega) = 0$.*

Lemma 3.26 $\alpha \in \Omega^p(M)$ is harmonic if and only if

$$d\alpha = 0 \text{ and } \delta\alpha = 0$$

Proof. Observe that

$$\begin{aligned}(\Delta\alpha, \alpha) &= (d\delta\alpha, \alpha) + (\delta d\alpha, \alpha) = \\ &= (\delta\alpha, \delta\alpha) + (d\alpha, d\alpha)\end{aligned}$$

Both terms are positive and vanish only if $d\alpha = 0$ resp. $\delta\alpha = 0$. The other implication is obvious. \square

Exercise 3.27 Prove that Δ is selfadjoint, that is,

$$(\Delta\alpha, \beta) = (\alpha, \Delta\beta)$$

for all $\alpha, \beta \in \Omega^p(M)$.

Eugenio Beltrami

Born : 16 november 1835 in Cremona (Italy)

Died : 4 june 1899 in Rome (Italy)



Eugenio Beltrami studied at Pavia (1853-56), then Milan, before being appointed to the University of Bologna in 1862 as a visiting professor of algebra and analytic geometry. In 1866 he was appointed professor of rational mechanics. Beltrami also worked at universities in Pisa, Rome, and Pavia. Influenced by Cremona, Lobachevsky, Gauss and Riemann, Beltrami contributed to work in differential geometry on curves and surfaces. He is best known, however, for his 1868 paper "Essay on an interpretation of non-euclidean geometry" which gives a concrete realization of the non-euclidean geometry of Lobachevsky and Bolyai and connects it with Riemann's geometry. The concrete realization uses the surface generated by the revolution of a tractrix about its asymptote.

Beltrami also worked on optics, thermodynamics, elasticity, electricity and magnetism. His contributions to these topics appeared in the four-volume work, "Opere Matematiche" (1902-20).

We now turn to implications of the above to de Rham cohomology. Define a bilinear map

$$H_{dR}^p(M, \mathbb{R}) \times H_{dR}^{d-p}(M, \mathbb{R}) \longrightarrow \mathbb{R}$$

by the formula

$$(\omega, \eta) \mapsto \int_M \omega \wedge \eta$$

for representatives ω, η in the cohomology classes. One can show that this definition is independent of these choices and that it defines a non-degenerate bilinear form. Therefore,

$$H_{dR}^p(M, \mathbb{R}) \simeq (H_{dR}^{d-p}(M, \mathbb{R}))^*$$

and we obtain **Poincaré-duality** for a compact oriented differentiable manifold of dimension d

$$b_p(M) = b_{d-p}(M)$$

Moreover, for such a manifold we have $b_0(M) = b_d(M) = 1$. This follows from the fact that every cohomology class in $H_{dR}^p(M, \mathbb{R})$ contains precisely one harmonic form and we have seen before that harmonic functions are constant.

Jules Henri Poincaré

Born : 29 april 1854 in Nancy (France)

Died : 17 july 1912 in Paris (France)



Henri Poincaré entered the Ecole Polytechnique in 1873 and continued his studies at the Ecole des Mines, as a student of Charles Hermite, from which he received his doctorate in mathematics in 1879. He was appointed to a

chair of mathematical physics at the Sorbonne in 1881, a position he held until his death. Before the age of 30 he developed the concept of automorphic functions which he used to solve second order linear differential equations with algebraic coefficients. His "Analysis situs" , published in 1895, is an early systematic treatment of topology. Poincaré; can be said to have been the originator of algebraic topology and of the theory of analytic functions of several complex variables. He also worked in algebraic geometry and made a major contribution to number theory with work on Diophantine equations. In applied mathematics he studied optics, electricity, telegraphy, capillarity, elasticity, thermodynamics, potential theory, quantum theory, theory of relativity and cosmology. He is often described as the last universalist in mathematics. The Poincaré conjecture is as one of the most baffling and challenging unsolved problems in algebraic topology. Homotopy theory reduces topological questions to algebra by associating with topological spaces various groups which are algebraic invariants. Poincaré introduced the fundamental group to distinguish different categories of two-dimensional surfaces. He was able to show that any 2-dimensional surface having the same fundamental group as the two-dimensional surface of a sphere is topologically equivalent to a sphere. He conjectured that the result held for 3-dimensional manifolds and this was later extended to higher dimensions. Surprisingly proofs are known for the equivalent of Poincaré's conjecture for all dimensions strictly greater than 3. No complete classification scheme for 3-manifolds is known so there is no list of possible manifolds that can be checked to verify that they all have different homotopy groups.

4 Lie groups

Rather than studying all vectorbundles on a differentiable manifold one restricts attention to families having the same local symmetry or structure group. These symmetry groups which are also very important in particle physics are Lie groups.

Marius Sophus Lie

Born : 17 december 1842 in Nordfjordeid (Norway)

Died : 18 february 1899 in Kristiania (Norway)



Lie was taught mathematics at school by Sylow and then attended Sylow's lectures on group theory at the University of Christiania from where he graduated in 1865 (not gaining a distinction). There followed a few years when he could not decide what career to follow. A turning point came in 1868 when he read papers on geometry by Poncelet and Plücker. In 1869 Lie went to Berlin where he met Felix Klein. They met again in Paris and Lie started to work on transformation groups. He was to collaborate later with Klein in publishing several papers. This joint work had as one of its outcomes Klein's characterization of geometry (1872) as properties invariant under a group action. While in Paris Lie discovered contact transformations. These transformations allowed a 1-1 correspondence between lines and spheres in such a way that tangent spheres correspond to intersecting lines. Because of the French-German war of 1870 both Klein and Lie left France, Lie deciding to go to Italy. On the way however he was arrested as a German spy and his mathematics notes were assumed to be coded messages. Only after the intervention of Darboux was Lie released and he decided to return to Christiania. In 1871 Lie became an assistant at Christiania (which became Kristiania then Oslo in 1925) and obtained his doctorate. Lie had started examining partial differential equations, hoping that he could find a theory which was analogous to Galois theory of equations. He examined his contact transformations considering how they affected a process due to Jacobi of generating further solutions from a given one. This led to combining the transformations in a way that Lie called a group, but which is not a group with our definition, rather what is today called a Lie algebra. At this point he left his original intention of examining partial differential equations and examined Lie algebras. Killing was to examine Lie algebras quite independently of Lie, and Cartan was

to publish the classification of semisimple Lie algebras in 1900. Lie collaborated for nine years with Engel after which Lie and Engel jointly published "Theorie der Transformationsgruppen" in three volumes in 1893. This was Lie's major work on continuous groups of transformations. Engel was a student of Klein's sent by him to study under Lie. In 1886 Lie succeeded Klein in the chair of mathematics at Leipzig with Engel as his assistant. In 1892 the lifelong friendship between Lie and Klein broke down and the following year Lie publicly attacked Klein saying "I am no pupil of Klein, nor is the opposite the case, although this might be closer to the truth." Lie returned to Kristiania in 1898 to take up a post specially created for him but his health was already deteriorating and he died soon after taking up the post.

4.1 Lie groups and Lie algebras.

Definition 4.1 A Lie group is a group G carrying the structure of a differentiable manifold, or more generally, of a disjoint union of finitely many differentiable manifolds for which the following maps are differentiable : the multiplication

$$G \times G \longrightarrow G \quad (g, h) \mapsto g.h$$

and the inverse

$$G \longrightarrow G \quad g \mapsto g^{-1}$$

Most of the Lie groups we will encounter are linear algebraic groups. We will describe some of the easier ones here. Throughout, V will be a vectorspace of dimension n . The **general linear group** $GL(V)$ is the group of all linear isomorphisms of V . If we fix a basis $V = \mathbb{R}^n$ we will often write $GL_n(\mathbb{R})$.

If V is equipped with an inproduct $\langle \cdot, \cdot \rangle$ we define the **orthogonal group**

$$O(V) = \{A \in GL(V) \mid \langle Av, Av \rangle = \langle v, v \rangle \text{ for all } v \in V\}$$

If the inproduct is given by the symmetric matrix Q we see that $O(V)$ consists of those $A \in GL(V)$ such that $A^T Q A = Q$. In particular, it follows that $\det A^2 = 1$ for all $A \in O(V)$. Hence, $O(V)$ is not a differentiable manifold because it is not connected. It has two connected component (the matrices with determinant one $SO(V)$ which form the **special orthogonoal group** and those with determinant -1). If we fix $V = \mathbb{R}^n$ with the standard Euclidian product then we denote $O_n(\mathbb{R})$ resp. $SO_n(\mathbb{R})$.

Because the connected component G_0 of the identity element e of G is a differentiable manifold, we can look at the tangent space $\mathfrak{g} = T_e G_0$. This turns out to be a Lie algebra.

Definition 4.2 A Lie algebra (over \mathbb{R}) is a real vectorspace W equipped with a bilinear map

$$[\cdot, \cdot] : W \times W \longrightarrow W$$

the Lie bracket which is anti-symmetric and satisfies the **Jacobi identity**

$$[u, [v, w]] + [v, [w, u]] + [w, [u, v]] = 0 \text{ for all } u, v, w \in W$$

For the Lie groups considered above, we have that $\mathfrak{gl}(V)$ is $M_n(\mathbb{R})$ (because $GL(V)$ is an open subset of the affine space $M_n(\mathbb{R})$ so the tangentspace coincides with $M_n(\mathbb{R})$) and the Lie bracket is given by

$$[a, b] = a.b - b.a \text{ for all } a, b \in M_n(\mathbb{R})$$

The Lie algebra $\mathfrak{so}(V)$ of $SO(V)$ is given by

$$\{a \in \mathfrak{gl}(V) \mid \langle av, w \rangle + \langle v, aw \rangle = 0 \text{ for all } v, w \in V\}$$

the space of skew-symmetric endomorphisms of V . If we fix the Euclidian product on $V = \mathbb{R}^n$ we will denote this Lie algebra with $\mathfrak{so}_n(\mathbb{R})$.

The relation between the Lie algebra and its Lie group is given by the exponential map which is

$$e^a = Id + a + \frac{1}{2!}a^2 + \frac{1}{3!}a^3 + \dots$$

and clearly we have $e^a e^{-a} = Id$ whence $e^a \in GL(V)$ for every $a \in \mathfrak{gl}(V)$. Similarly, as the inproduct on V is nondegenerate, for every $a \in \mathfrak{gl}(V)$ one has an adjoint a^* determined by

$$\langle av, w \rangle = \langle v, a^*w \rangle \text{ for all } v, w \in V$$

and we have that $a \in \mathfrak{so}(V)$ if and only if $a = -a^*$. But then, for $a \in \mathfrak{so}(V)$ we have

$$(e^a)^* = id + a^* + \frac{1}{2!}(a^*)^2 + \dots = id - a + \frac{1}{2!}a^2 + \dots = (e^a)^{-1}$$

whence $e^a \in SO(V)$.

Sometimes, we need complex vectorspaces. Let $V_{\mathbb{C}}$ be a vectorspace over \mathbb{C} of dimension n and let $GL(V_{\mathbb{C}})$ be the group of all complex linear isomorphisms. If we fix $V_{\mathbb{C}} = \mathbb{C}^n$, then we write $GL_n(\mathbb{C})$. Clearly, $GL(V)$ is a manifold of dimension $2n^2$.

If $V_{\mathbb{C}}$ is equipped with an Hermitian inproduct $\langle \cdot, \cdot \rangle$ we define the **unitary group**

$$U(V_{\mathbb{C}}) = \{A \in GL(V_{\mathbb{C}}) \mid \langle Av, Aw \rangle = \langle v, w \rangle \text{ for all } v, w \in V_{\mathbb{C}}\}$$

and the **special unitary group** $SU(V)$ to be the subgroup of $U(V)$ of matrices with determinant one. If we fix $V_{\mathbb{C}} = \mathbb{C}^n$ with the standard Hermitian product we write $U_n(\mathbb{C})$ and $SU_n(\mathbb{C})$.

4.2 Structure groups and bundles.

Let us consider again a vectorbundle of rank n over M

$$(E, \pi, M)$$

and let $(U_\alpha)_\alpha$ be an open covering of M over which the bundle is trivial and fix corresponding local trivializations

$$\pi^{-1}(U_\alpha) \xrightarrow{\phi_\alpha} U_\alpha \times \mathbb{R}^n$$

then we obtain **transition maps**

$$U_\alpha \cap U_\beta \xrightarrow{\phi_{\alpha\beta}} GL_n(\mathbb{R})$$

defined by for $p \in M$ and $v \in \mathbb{R}^n$

$$\phi_\beta \circ \phi_\alpha^{-1}(p, v) = (p, \phi_{\alpha\beta}(p)v)$$

These transition maps satisfy the following properties

$$\begin{aligned} \phi_{\alpha\alpha}(p) &= id_{\mathbb{R}^n} && \text{for } p \in U_\alpha \\ \phi_{\alpha\beta}(p)\phi_{\beta\alpha}(p) &= id_{\mathbb{R}^n} && \text{for } p \in U_\alpha \cap U_\beta \\ \phi_{\alpha\gamma}(p)\phi_{\gamma\beta}(p)\phi_{\beta\alpha}(p) &= id_{\mathbb{R}^n} && \text{for } p \in U_\alpha \cap U_\beta \cap U_\gamma \end{aligned}$$

Conversely, given transition maps satisfying these conditions we can (re)construct a vectorbundle of rank n over M .

Proposition 4.3 Consider on the disjoint union $\bigcup_\alpha U_\alpha \times \mathbb{R}^n$ the equivalence relation

$$(p, v) \sim (q, w) \text{ iff } p = q \text{ and } w = \phi_{\beta\alpha}(v)$$

when $p \in U_\alpha, q \in U_\beta$ and $v, w \in \mathbb{R}^n$. Then, the set of equivalence relations

$$E = \bigcup_\alpha U_\alpha \times \mathbb{R}^n / \sim$$

is a vectorbundle of rank n over M .

Proof. Exercise ! Check the properties required in the definition of a vectorbundle. □

Definition 4.4 Let G be a subgroup of $GL_n(\mathbb{R})$. We say that a vectorbundle has **structure group** G if there exists an atlas of bundle charts for which all the transition maps have their values in G .

Proposition 4.5 The tangent bundle TM of a Riemannian manifold of dimension d has structure group $O_d(\mathbb{R})$.

Proof. Let (f, U) be a bundle chart for TM

$$\pi^{-1}(U) \xrightarrow{f} U \times \mathbb{R}^d$$

Let e_1, \dots, e_d be the canonical basis vectors of \mathbb{R}^d and consider sections v_1, \dots, v_d of $\pi^{-1}(U)$ such that $f(v_i(p)) = (p, e_i)$ for all i . Apply the Gram-Schmidt orthogonalization procedure to $\{v_1(p), \dots, v_d(p)\}$ for all $p \in U$ to obtain sections $\{w_1, \dots, w_d\}$ of $\pi^{-1}(U)$ such that $\{w_1(p), \dots, w_d(p)\}$ are an orthonormal basis with respect to the Riemannian metric on $T_x M$ for every $p \in U$. We can now construct a new bundlechart

$$\pi^{-1}(U) \xrightarrow{f'} U \times \mathbb{R}^d$$

by sending $\sum \lambda_i w_i(p)$ to $(p, \lambda_1, \dots, \lambda_d)$. We then get a bundle chart which maps for every $p \in U$ an orthonormal basis for the Riemannian metric onto an Euclidian orthonormal basis of \mathbb{R}^d .

We apply this procedure to every bundle chart to obtain a new bundle atlas whose transition maps always map an Euclidian orthonormal basis of \mathbb{R}^d into another such basis, whence the transition maps are in $O_d(\mathbb{R})$. \square

Definition 4.6 *A manifold is said to be **oriented** provided the tangent bundle has a bundle atlas such that all the transition maps have positive determinant.*

Proposition 4.7 *The tangent bundle of an oriented Riemannian manifold of dimension d has structure group $SO_n(\mathbb{R})$.*

Proof. Combine the above proof with the definition of orientability. \square

Analogous to the definition of a vectorbundle where the fibers are vectorspaces we can define a principal bundle as one where the fibers are all a fixed Lie group.

Definition 4.8 *Let G be a Lie group. A **principal G -bundle** consists of a base M which is a differentiable manifold, a total space of the bundle P which is a differentiable manifold and a differentiable projection*

$$P \xrightarrow{\pi} M$$

We have an action of G on P satisfying the following properties.

1. G acts freely on P from the right, that is, $p.g \neq p$ if $e \neq g \in G$. The G -action then defines an equivalence relation on P : $p \sim q$ iff there exists $g \in G$ such that $p.g = q$.

2. M is the quotient of P under this equivalence relation and the bundle projection π maps p to its equivalence class. Each fiber $\pi^{-1}(x)$ can then be identified to G .
3. For every $x \in M$ there is an open neighborhood U and a diffeomorphism

$$\pi^{-1}(U) \xrightarrow{\phi} U \times G$$

which is G -equivariant, that is, if $\phi(p) = (\pi(p), \psi(p))$ then $\phi(p.g) = (\pi(p), \psi(p).g)$ for all $g \in G$.

A subgroup H is called the **structure group** of the principal bundle P if all transition maps take their values in H . Here, the structure group operates on G by left translations.

Principal bundles and vectorbundles are closely related. Given a principal G -bundle $P \longrightarrow M$ and a vectorspace V on which G acts from the left, we will construct an **associated vectorbundle** $E \longrightarrow M$ with fiber V .

There is an action of G on $P \times V$ by the rule

$$(p, v).g = (p.g, g^{-1}.v)$$

which is clearly free. If we divide out this action, that is, if we identify (p, v) and $(p, v).g$ we obtain the situation

$$E = P \times_G V = (P \times V)/G \quad \xrightarrow{pr_1} \quad P/G = M.$$

This is a vectorbundle with fibers isomorphic to V and with structure group G . The transition functions for P also give transition functions for E via the left action of G on V .

Conversely, given a vectorbundle $E \longrightarrow M$ with structure group G , we can construct the principal bundle P of **admissible bases** of E as the quotient space

$$P = \bigcup_{\alpha} U_{\alpha} \times G / \sim$$

where two points are equivalent $(x_{\alpha}, g_{\alpha}) \sim (x_{\beta}, g_{\beta})$ if and only if $x = x_{\alpha} = x_{\beta}$ on $U_{\alpha} \cap U_{\beta}$ and $g_{\beta} = \phi_{\beta\alpha}(x)g_{\alpha}$. In a local trivializations U_{α} each fiber of E is identified with \mathbb{R}^n and each admissible basis is represented by a matrix contained in G .

Example 4.9 *If we have a vectorbundle E on M with structure group $SO_d(\mathbb{R})$ (for example, the tangent bundle when M is an oriented manifold of dimension d), then the associated principal $SO_d(\mathbb{R})$ -bundle is the **frame bundle** of E , that is the bundle of oriented orthonormal bases for the fibres of E .*

4.3 Fundamental group and covers.

Let M be a connected manifold. A **path** in M is a continuous map

$$[0, a] \xrightarrow{c} M$$

for $a \geq 0$. A path is called a **loop** if $c(0) = c(a) \in M$, this point is then called the **base point** of the loop. The **inverse** of a path c is the path

$$[0, a] \xrightarrow{c^{-1}} M$$

where $c^{-1}(t) = c(a - t)$.

For two paths $[0, a_i] \xrightarrow{c_i} M$ with $c_2(0) = c_1(a_1)$ we define the product $c = c_1.c_2$ (or concatenation) to be the path

$$[0, a_1 + a_2] \xrightarrow{c} M$$

where

$$c(t) = \begin{cases} c_1(t) & \text{for } 0 \leq t \leq a_1 \\ c_2(t - a_1) & \text{for } a_1 \leq t \leq a_1 + a_2 \end{cases}$$

We call two paths $[0, a_i] \xrightarrow{c_i} M$ with $c_1(0) = c_2(0)$ and $c_1(a_1) = c_2(a_2)$ **homotopic** if there exists a continuous function

$$[0, 1] \times [0, 1] \xrightarrow{H} M$$

with

$$\begin{aligned} H(t, 0) &= c_1\left(\frac{t}{a_1}\right) \\ H(t, 1) &= c_2\left(\frac{t}{a_2}\right) \quad \text{for all } t \\ H(0, s) &= c_1(0) = c_2(0) \\ H(1, s) &= c_1(a_1) = c_2(a_2) \quad \text{for all } s \end{aligned}$$

This defines an equivalence relation on the set of all paths and we will denote the equivalence class of path c by $|c|$. One verifies that $|c_1.c_2|$ and $|c^{-1}|$ are independent of the choice of representative. Therefore, we can define

$$\begin{aligned} |c_1.c_2| &= |c_1| \cdot |c_2| \\ |c^{-1}| &= |c|^{-1} \end{aligned}$$

In particular, the homotopy classes of loops with fixed basepoint $p \in M$ form a group

$$\pi_1(M, p)$$

the **fundamental group** of M with basepoint p .

If $p, q \in M$ and $[0, 1] \xrightarrow{\gamma} M$ is a path with $\gamma(0) = p$ and $\gamma(1) = q$, then for every loop c with basepoint q we have that $\gamma^{-1}.c.\gamma$ is a loop with basepoint p and this induces an isomorphism between the groups $\pi_1(M, a)$ and $\pi_1(M, q)$. We may thus speak of the fundamental group $\pi_1(M)$ of the manifold M .

Example 4.10 1. $\pi_1(\mathbb{R}^n) = \{1\}$ for all n .

2. $\pi_1(S^1) = \mathbb{Z}$ and a generator is given by the loop $[0, 1] \xrightarrow{c} S^1$ where

$$c(t) = (\cos 2\pi t, \sin 2\pi t)$$

3. $\pi_1(S^n) = \{1\}$ for all $n \geq 2$.

4. $\pi_1(SO_n(\mathbb{R})) = \mathbb{Z}/2\mathbb{Z}$ for all $n \geq 3$.

A manifold is said to be **simply connected** if $\pi_1(M) = \{1\}$. Any continuous map $M \xrightarrow{f} N$ induces a morphism $\pi_1(M) \xrightarrow{f_*} \pi_1(N)$ between the fundamental groups.

A continuous map $X \xrightarrow{\pi} M$ is called a **cover** if each $p \in M$ has an open neighborhood U such that each connected component of $\pi^{-1}(U)$ is mapped homeomorphically onto U .

If $p \in M$ and H is a subgroup of $\pi_1(M, p)$, then there exists a cover $X \xrightarrow{\pi} M$ with the property that for any $x \in X$ lying over p we have $\pi_*(\pi_1(X, x)) = H$. In particular, if we choose $H = \{1\}$, we obtain a simply connected manifold \tilde{M} and a cover

$$\tilde{M} \xrightarrow{\pi} M$$

\tilde{M} is called the **universal cover** of M .

Example 4.11 The universal cover of S^1 is \mathbb{R}^1 and the covering map π is given by

$$\pi(t) = (\cos 2\pi t, \sin 2\pi t)$$

We will show in some detail that $SU_2(\mathbb{C})$ is the universal cover of $SO_3(\mathbb{R})$.

By definition $SU_2(\mathbb{C})$ is the group of 2×2 special unitary matrices with determinant one. If

$$P = \begin{bmatrix} a & b \\ c & d \end{bmatrix} \text{ with } a, b, c, d \in \mathbb{C}$$

then the requirements $P^{-1} = P^*$ (P^* is the conjugate transpose) and $\det P = 1$ translate into

$$\bar{a} = d \text{ and } \bar{b} = -c$$

That is,

$$P = \begin{bmatrix} a & b \\ -\bar{b} & \bar{a} \end{bmatrix}$$

and the condition that $\det P = 1$ give the condition

$$a\bar{a} + b\bar{b} = 1$$

or equivalently, P is fully determined by a vector $(a, b) \in \mathbb{C}^2$ of length one. If we write a, b in terms of their real and imaginary parts, then the above condition translates into

$$x_1^2 + x_2^2 + x_3^2 + x_4^2 = 1$$

that is the unit sphere in \mathbb{R}^4 . Thus we have proved that

Proposition 4.12 *$SU_2(\mathbb{C})$ is homeomorphic to S^3 and is therefore a simply connected manifold.*

Recall that two elements g, h of a group G are said to be **conjugated** if there exists an $x \in G$ such that $x^{-1}gx = h$. For $SU_2(\mathbb{C})$ we give a geometric interpretation of the conjugacy classes. The matrices $\pm I_2$ correspond to the points $(\pm 1, 0, 0, 0) \in S^3$ and can be viewed as the 'north and south poles'. Analogous to the latitudes on S^2 we have the sets

$$L(c) = \{x_1 = c \text{ and } x_2^2 + x_3^2 + x_4^2 = 1 - c^2\}$$

for $-1 < c < 1$. Clearly each $L(c)$ is a two-dimensional sphere S^2 embedded in \mathbb{R}^3 .

Proposition 4.13 *Apart from the classes $\pm I_2$, the conjugacy classes of $SU_2(\mathbb{C})$ are the latitudes $L(c)$.*

Proof. The characteristic polynomial of the matrix $P = \begin{bmatrix} a & b \\ -\bar{b} & \bar{a} \end{bmatrix}$ is

$$X^2 - (a + \bar{a})X + 1 = X^2 - 2x_1X + 1$$

Two conjugated matrices have the same characteristic polynomial whence belong to the same $L(c)$. For $c \notin \{1, -1\}$ the polynomial has two distinct conjugate roots $\{\lambda, \bar{\lambda}\}$ (the eigenvalues of the matrix).

For $P \in SU_2(\mathbb{C})$ we claim that P is conjugated to a matrix of the form

$$\begin{bmatrix} \lambda & 0 \\ 0 & \bar{\lambda} \end{bmatrix}$$

From the theory of Hermitian forms we know that there is $Q \in U_2(\mathbb{C})$ such that QPQ^* is diagonal. Clearly, $\delta = \det Q$ has absolute value one and if we take $\epsilon = \sqrt{\delta}$ then $Q' = \bar{\epsilon}Q \in SU_2(\mathbb{C})$ and also $Q'PQ'^*$ is diagonal proving the claim. \square

An element $P \in SU_2(\mathbb{C})$ acts on each of the conjugacy classes $L(c) = S^2$ by conjugation. One can show that these actions are given by rotations and that this action gives a group epimorphism

$$SU_2(\mathbb{C}) \xrightarrow{\phi} SO_3(\mathbb{R})$$

whose kernel is the center $Z = \{\pm I_2\}$ of $SU_2(\mathbb{C})$. This homomorphism is called the **orthogonal representation** of $SU_2(\mathbb{C})$ and assigns to the complex matrix P the real rotation matrix

$$\phi(P) = \begin{bmatrix} (a\bar{a} - b\bar{b}) & i(\bar{a}b - a\bar{b}) & (\bar{a}b + a\bar{b}) \\ i(\bar{a}b - ab) & \frac{1}{2}(a^2 + \bar{a}^2 + b^2 + \bar{b}^2) & \frac{i}{2}(a^2 - \bar{a}^2 - b^2 + \bar{b}^2) \\ -(\bar{a}b + ab) & \frac{i}{2}(\bar{a}^2 - a^2 + \bar{b}^2 - b^2) & \frac{1}{2}(a^2 + \bar{a}^2 - b^2 - \bar{b}^2) \end{bmatrix}$$

Proposition 4.14 $SO_3(\mathbb{R})$ is homeomorphic to $\mathbb{P}^3(\mathbb{R})$ and has

$$\pi_1(SO_3(\mathbb{R})) = \mathbb{Z}/2\mathbb{Z}$$

whence the double cover $SU_2(\mathbb{C}) \xrightarrow{\phi} SO_3(\mathbb{R})$ is the universal cover.

Proof. Any rotation is fully determined by its axis of symmetry (determined by a unit vector $v \in \mathbb{R}^3$) and by the rotation angle $\theta \in [0, \pi]$. That is, a rotation determines a point θv in the closed ball B^3 in \mathbb{R}^3 with radius π . This correspondence is not unique since a rotation about v through an angle π is the same as a rotation through $-v$ through an angle π . Thus, opposite points on the boundary S^2 of B^3 must be identified giving a description of $\mathbb{P}^3(\mathbb{R})$.

$SO_3(\mathbb{R})$ is not simply connected. The closed loops fall into two disjoint classes, I and II, according as they have an odd or even number of 'intersections' with the boundary S^2 of B^3 . An intersection occurs when a curve approaches S^2 and then by identification of points reappears diametrically opposite. Class I contains for example all diameters of $SO_3(\mathbb{R})$ and class II contains all internal loops. No loop of class I can be transformed continuously into a loop of class II since intersection points with S^2 can disappear in pairs only.

On the other hand, all class I loops can be deformed into each other because intersections with S^2 can be eliminated in pairs and the same holds for class II loops. Finally, internal loops can be deformed into each other as can loops which intersect the boundary once. \square

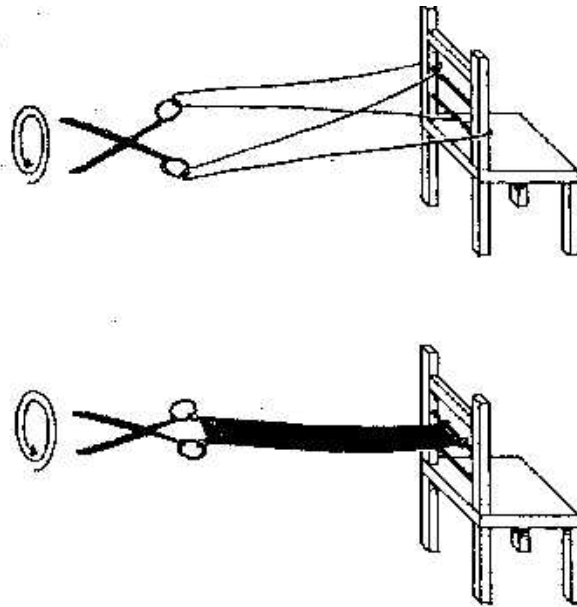

Now consider a continuous rotation of an object in \mathbb{R}^3 which takes that object back to its original orientation. This corresponds to a closed loop in $SO_3(\mathbb{R})$ which may be of class I or II. In the case of a single rotation through 2π we evidently get a class I loop whereas for a rotation through 4π we get a class II loop. Hence, a rotation through 2π (where the whole motion must be considered, not just the initial and final orientations) cannot be continuously deformed into no motion at all, whereas a rotation through 4π can.

In Dirac's well known **scissor problem** a piece of string is passed through a finger hole of the scissors, then around the back strut of a chair, then through the other finger hole and around the other back strut, and then tied. The scissors are rotated through 4π about their axis of symmetry and the problem is to disentangle the string without rotating the scissors or moving the chair. The fact that this problem can be solved for 4π but not for 2π is a consequence of the fact that $SO_3(\mathbb{R})$ is not simply connected.

4.4 Spin structures.

The discussion above can be generalized to any n , that is, there exists a special two-fold covering group of $SO_n(\mathbb{R})$ which is called the **spin group** $Spin_n$ and which is important in the study of 3- and 4- dimensional manifolds. In this subsection we will describe it briefly.

William Kingdom Clifford

Born : 4 may 1845 in Exeter (England)

Died : 3 march 1879 on the Madeira Islands (Portugal)



William Clifford studied non-euclidean geometry arguing that energy and matter are simply different types of curvature of space. He introduced what is now called a Clifford algebra which generalizes Grassmann's exterior algebra. William showed great promise at school where he won prizes in many different subjects. At age 15 he was sent to King's College, London where he excelled in mathematics and also in classics, English literature and (perhaps unexpectedly) in gymnastics. When he was 18 years old William entered Trinity College, Cambridge. He won not only prizes for mathematics but also a prize for a speech he delivered on Sir Walter Raleigh. He was second wrangler in his final examinations (in common with many other famous mathematicians who were second at Cambridge like Thomson and Maxwell). He was elected to a Fellowship at Trinity in 1868. In 1870 he was part of an expedition to Italy to obtain scientific data from an eclipse. He had the unfortunate experience of being shipwrecked near Sicily, but he was fortunate to survive. In 1871 Clifford was appointed to the chair of Mathematics and Mechanics at University College London. In 1874 he was elected a Fellow of the Royal Society. He was also an enthusiastic member of the London Mathematical Society which held its meetings at University College. Influenced by the work of Riemann and Lobachevsky, Clifford studied non-euclidean geometry. In 1870 he wrote "On the space theory of matter" in which he argued that energy and matter are simply different types of curvature of space. In this work he presents ideas which were to form a fundamental role in Einstein's general theory of relativity. Clifford generalized the quaternions (introduced by Hamilton two years before Clifford's birth) to what he called the biquaternions and he used them to study motion in non-euclidean spaces and on certain surfaces. These are now known as 'Clifford-Klein spaces'. He showed that spaces of constant curvature could have several different topological structures. Clifford also proved that a Riemann surface is topologically equivalent to a box with holes in it. He shared with Charles Dodgson the pleasure of entertaining children. Although he never rivalled Dodgson's Lewis Carroll books in success, Clifford wrote "The Little People" , a collection of fairy stories written to amuse children. In 1876 Clifford suffered a physical collapse. This was certainly made worse by overwork if not completely caused by it. He would spend the day with teaching and administrative duties, then spend all night at his research. Six months spent in Algeria and Spain allowed him to recover sufficiently to resume his duties for 18 months but, perhaps inevitably, he again collapsed. A period spent in Mediterranean countries did little for his health and after a couple of months back in England in late 1878 he left for Madeira. The hoped for recovery never materialized and he died a few months later.

Let $V = \mathbb{R}^n$ be Euclidian space with orthonormal basis $\{e_1, \dots, e_n\}$ then the **Clifford algebra** $Cl(V)$ is the (non-commutative) algebra with generators e_i and defining relations

$$e_i^2 = -1 \text{ and } e_j e_i = -e_i e_j \text{ for } i \neq j$$

One verifies that a basis of $Cl(V)$ as a real vector space is given by

$$e_0 = 1 \quad e_\alpha = e_{\alpha_1} e_{\alpha_2} \dots e_{\alpha_k}$$

with $\alpha = \{\alpha_1, \dots, \alpha_k\} \subset \{1, \dots, n\}$ and $\alpha_1 < \dots < \alpha_k$. For such an α we put $|\alpha| = k$ and say that e_α is an element of degree k .

Therefore, $Cl(V)$ has dimension 2^n and declaring the above basis to be orthonormal we obtain an inproduct on $Cl(V)$ extending the one on V . With Cl^k we will denote the subspace of elements of degree k and with Cl^{ev} and Cl^{odd} the subspaces of even resp. odd degree.

Exercise 4.15 Show that Cl^2 with the bracket

$$[a, b] = a.b - b.a \text{ multiplication in } Cl(V)$$

is a Lie algebra of dimension $\binom{n}{2}$ which will be denoted \mathfrak{spin}_n .

Precisely as we obtained $GL_n(\mathbb{R})$ from $M_n(\mathbb{R})$ by exponentiating the Lie algebra \mathfrak{gl}_n , we can exponentiate \mathfrak{spin}_n in the algebra $Cl(V)$ to obtain a Lie group $Spin_n$. To describe it concretely we first introduce an anti-automorphism $a \mapsto a^t$ of $Cl(V)$ defined on the basis by

$$(e_{\alpha_1} e_{\alpha_2} \dots e_{\alpha_k})^t = e_{\alpha_k} \dots e_{\alpha_2} e_{\alpha_1}$$

and extend it linearly, then one verifies that for all $a, b \in Cl(V)$ one has

$$(ab)^t = b^t a^t$$

Definition 4.16 $Spin_n$ is the group of elements of $Cl(V)$ of the form

$$a = a_1.a_2.\dots.a_{2m} \text{ with } a_i \in V \text{ and } \|a_i\| = 1$$

for $1 \leq i \leq 2m$ with $m \in \mathbb{N}$.

After a lot of computations one can prove the following result

Theorem 4.17 *There is an action of $Spin_n$ on V defined by*

$$\rho(a)v = a.v.a^t$$

which defines a group epimorphism

$$Spin_n \xrightarrow{\rho} SO_n(\mathbb{R})$$

with kernel $\{\pm 1\}$. Moreover, $Spin_n$ is compact and connected and for $\dim V \geq 3$ it is also simply connected. Thus, for $\dim V \geq 3$, $Spin_n$ is the universal cover of $SO_n(\mathbb{R})$.

Exercise 4.18 *(not easy !)* *Prove the following isomorphisms*

1. $Spin_2 \simeq U_1(\mathbb{C})$ homeomorphic to S^1 .
2. $Spin_3 \simeq SU_2(\mathbb{C})$ homeomorphic to S^3 .
3. $Spin_4 \simeq SU_2(\mathbb{C}) \times SU_2(\mathbb{C})$ homeomorphic to $S^3 \times S^3$.

Sometimes we need the complex Clifford algebra

$$Cl^{\mathbb{C}}(V) = Cl(V) \otimes_{\mathbb{R}} \mathbb{C}$$

and the Lie group $Spin_n^{\mathbb{C}}$ which is by definition the subgroup of the multiplicative group of $Cl^{\mathbb{C}}(V)$ generated by $Spin_n$ and the unit circle in \mathbb{C} . There is an action of $\mathbb{Z}/2\mathbb{Z}$ on $Spin_n^{\mathbb{C}}$ such that the quotient yields a double covering

$$Spin_n^{\mathbb{C}} \longrightarrow SO_n \times S^1$$

that is nontrivial on both factors.

This Lie group is no longer simply connected. In fact one can prove that

$$\pi_1(Spin_n^{\mathbb{C}}) = \mathbb{Z} \text{ for } n \geq 3$$

and as above one has the following realizations in small dimensions

1. $Spin_2^{\mathbb{C}} \simeq U_1(\mathbb{C}) \times U_1(\mathbb{C})$ homeomorphic to the torus.
2. $Spin_3^{\mathbb{C}} \simeq U_2(\mathbb{C})$.
3. $Spin_4^{\mathbb{C}} \simeq \{(U, V) \in U_2(\mathbb{C}) \times U_2(\mathbb{C}) \mid \det U = \det V\}$.

For even dimensional V we can describe $Cl^{\mathbb{C}}(V)$ as the full matrixalgebra of linear endomorphisms of a certain complex vectorspace S_n , the **spinor space**. To describe it let W be the (complex) subspace of $V \otimes \mathbb{C}$ spanned by the vectors

$$\eta_j = \frac{1}{\sqrt{2}}(e_{2j-1} - ie_{2j})$$

for $1 \leq j \leq m$ where $m = 2n$. Then S_n is by definition the complex exterior algebra of W . We have that

$$V \otimes \mathbb{C} = W + \overline{W}$$

and an action of $V \otimes \mathbb{C}$ on S_n defined by

$$\rho(w + w')s = \sqrt{2}w \wedge s - \sqrt{2}i(w')s$$

where $v \in V \otimes \mathbb{C}$ is written as $w + w'$ and $i(w')$ is the interior product after identifying \overline{W} with the dual space W^* . We extend ρ to an action of $Cl^{\mathbb{C}}(V)$ on S_n by the rule that $\rho(ab) = \rho(a)\rho(b)$. Then one has

$$Cl^{\mathbb{C}}(V) \simeq End_{\mathbb{C}}(S_n)$$

and the corresponding representation of $Spin_n \subset Cl^{\mathbb{C}}(V)$ is called the **spinor representation**.

After these preliminaries, we can define spin structures on an oriented Riemannian manifold M . Let TM be the tangent bundle of M which we have seen to have structure group $SO_n(\mathbb{R})$. We let P be the associated principal bundle over M , the so called frame bundle of M .

Definition 4.19 *A spin structure on M is a principal bundle \tilde{P} over M with fiber $Spin_n$ for which the quotient of each fiber by the center ± 1 is isomorphic to the frame bundle P of M .*

*A Riemannian manifold with a fixed spin structure is called a **spin manifold**.*

The existence of a spin structure depends on a topological condition, the vanishing of the so called **Stieffel-Whitney class**. Moreover, if a spin structure exists it need not be unique.

For a given spin structure $\tilde{P} \longrightarrow M$, the fiber $Spin_n$ acts on the spinor space n and hence we obtain the associated vector bundle

$$\mathcal{S}_n = \tilde{P} \times_{Spin_n} S_n$$

which is called the **spinor bundle** on M .

We can also ask for a lift of the frame bundle P to a principal $Spin_n^c$ -bundle \tilde{P}^c where the requirement is that the map from a fiber of \tilde{P}^c to the corresponding fiber of P is given by the homomorphism

$$Spin_n^c \longrightarrow SO_n(\mathbb{R})$$

determined by the cover $Spin_n^c \longrightarrow SO_n(\mathbb{R}) \times S^1$ composed with projection on the first factor.

Definition 4.20 *Such a principal $Spin_n^c$ -bundle \tilde{P}^c is called a $spin^c$ structure on M . An oriented Riemannian manifold M equipped with a fixed $spin^c$ structure is called a $spin^c$ manifold.*

Again, the existence of a $spin^c$ structure is determined by a topological condition. One has proved that this condition is satisfied for all oriented Riemannian manifolds of dimension 4. Thus, each oriented differentiable four-manifold possesses a $spin^c$ structure. Again, we have an associated spinor bundle \mathcal{S}_n^c . As $SO_n(\mathbb{R})$ acts on $Cl(V)$ and $Cl^c(V)$ by extending the action on \mathbb{R}^n we also have associated bundles

$$Cl(P) = P \times_{SO_n(\mathbb{R})} Cl(\mathbb{R}^n)$$

$$Cl^c(P) = P \times_{SO_n(\mathbb{R})} Cl^c(\mathbb{R}^n)$$

which are called the **Clifford bundles** on M .

5 Connections.

Roughly speaking, a connection is a rule which allows us to take derivatives of sections of vectorbundles. In order to understand the problem and its solution, we will briefly consider the classical case.

Let X be a vectorfield on \mathbb{R}^d , $p \in \mathbb{R}^d$ and V a vector at p . We want to analyze how one takes a derivative of X at p in the direction V . The natural choice is

$$dX(V)(p) = \lim_{t \rightarrow 0} \frac{X(p + tV) - X(p)}{t}$$

Recall that a vectorfield X is a section of the tangentbundle $T\mathbb{R}^d$. Thus, $X(p + tV) \in T_{p+tV}(\mathbb{R}^d)$ while $X(p) \in T_p(\mathbb{R}^d)$ and the vectors hence lie in distinct vectorspaces so in order for their difference to make sense we have to be able to identify these spaces.

In \mathbb{R}^d this is easy, and one can identify any $T_x(\mathbb{R}^d)$ with $T_0(\mathbb{R}^d) \simeq \mathbb{R}^d$ by identifying the tangent vector $\frac{\partial}{\partial x_i}$ at x with $\frac{\partial}{\partial x_i}$ at O .

A geometric way to view this identification is to consider a curve

$$[0, 1] \xrightarrow{c} \mathbb{R}^d$$

with $c(t) = tx$, that is, the straight line joining 0 and x . For any vector X_1 at x one forms a vector X_t at $c(t) = tx$ having the same length and parallel to X_1 that is making the same angle with c . X_0 is then the vector which is identified with X_1 .

On a differentiable manifold however there is no canonical way to identify tangent spaces at different points, or more generally, fibers of vectorbundles at different points. Thus we have to expect that a notion of derivative for sections of a vectorbundle has to depend on certain choices.

Throughout, M will be a differentiable manifold and E will be a vectorbundle over M . In analogy with the definition of p -forms on M we define **p -forms on M with values in E** to be the space

$$\Omega^p(E) = \Gamma(\wedge^p T^*M \otimes E)$$

That is, if $\phi \in \Omega^p(E)$, then for every $p \in M$, ϕ_p is a p -linear alternating map

$$\phi_p : T_pM \times \dots \times T_pM \longrightarrow E_p$$

Observe that $\Omega^0(E) = \Gamma(E)$ and $\Omega^1(E) = \Gamma(T^*M \otimes E)$.

Definition 5.1 *A connection on E is a linear map*

$$\nabla : \Omega^0(E) \longrightarrow \Omega^1(E)$$

satisfying the condition

$$\nabla(f\phi) = df \otimes \phi + f\nabla(\phi)$$

for any $f \in C^\infty(M)$ and any $\phi \in \Omega^0(E)$.

Given a section $\phi \in \Omega^0(E) = \Gamma(E)$, we have a linear map

$$\nabla(\phi)_p : T_pM \longrightarrow E_p$$

Thus, for any tangent vector V at any point $p \in M$ we are given the **covariant derivative** $\nabla_V(\phi) \in E_p$ of ϕ in the direction V at p .

If V is a globally defined smooth vectorfield, that is $V \in \Gamma(TM)$, then $\nabla_V\phi$ is again a smooth section of E . That is, we have a linear map

$$\nabla_V : \Omega^0(E) \longrightarrow \Omega^0(E)$$

The requirement can then be restated as

$$\nabla_V(f\phi) = (Vf)\phi + f\nabla_V(\phi)$$

for all smooth vectorfields V and all ϕ, f as before.

Clearly, the differentiation of a vectorfield in \mathbb{R}^d described before is a connection if we take $\nabla_V(X) = d(X)(V)$.

Proposition 5.2 *Let M be a differentiable manifold and E a vectorbundle on M , then there exist connections on E .*

Proof. Let $p \in M$ and choose an open neighborhood U admitting a chart of M and a bundle chart of E , then we have an identification

$$E|U \simeq U \times \mathbb{R}^n$$

Sections on U are now just \mathbb{R}^n valued functions and with respect to the coordinate vectorfields

$$\left\{ \frac{\partial}{\partial x_1}, \dots, \frac{\partial}{\partial x_n} \right\}$$

we can define a connection

$$\nabla_U : \Omega^0(\mathbb{R}^n) \longrightarrow \Omega^1(\mathbb{R}^n)$$

which is just n copies of the de Rham exterior derivation, that is, for $\nabla = \nabla_U$

$$\nabla_{\frac{\partial}{\partial x_i}} \phi = d\phi\left(\frac{\partial}{\partial x_i}\right) = \frac{\partial \phi}{\partial x_i}$$

for any \mathbb{R}^n valued function ϕ .

But, of course, this connection depends on the choice of the trivialization. Now, if ∇_1 and ∇_2 are connections on E and f is a smooth real valued function, then one verifies that the convex combination

$$f\nabla_1 + (1 - f)\nabla_2$$

is again a connection on E .

Therefore, the connections on the local trivializations of E given above can be spliced together by a partition of unity to give a connection on E . \square

In a local trivialization as above the standard basis of \mathbb{R}^n gives rise to linearly independent sections $\{\mu_1, \dots, \mu_n\}$ in $\Gamma(E | U)$. We can then define **generalized Christoffel symbols** by

$$\nabla_{\frac{\partial}{\partial x_i}} \mu_j = \sum_{k=1}^n \Gamma_{ij}^k \mu_k$$

The image of an arbitrary section over U is then

$$\nabla \left(\sum_{j=1}^n a_j \mu_j \right) = \sum_{j=1}^n d(a_j) \mu_j + \sum_{j=1}^n a_j A \mu_j$$

where $A \in \Gamma(\mathfrak{gl}_n(\mathbb{R}) \otimes T^*M | U)$, that is, A is a matrix with values in T^*M such that

$$A \left(\frac{\partial}{\partial x_i} \right) = (\Gamma_{ij}^k)_{j,k}$$

Therefore, we can write formally

$$\nabla = d + A$$

The space of all connections on a given vectorbundle is an affine space and for two connections $\nabla_1 = d + A_1$ and $\nabla_2 = d + A_2$, the difference

$$\nabla_1 - \nabla_2 = A_1 - A_2$$

is a $\mathfrak{gl}_n(\mathbb{R})$ -valued 1-form, that is, an element of $\Omega^1(End E)$ where $End E$ is the bundle of vectorbundle endomorphisms of E . $End E$ is a vectorbundle with fibers isomorphic to $\mathfrak{gl}_n(\mathbb{R})$.

Given a connection ∇ on a vectorbundle E , there are naturally induced connections on E^* , $\otimes^r E$, $\wedge^r E$ etc. in a canonical way. In particular, for the vectorbundle $End(E) = E^* \otimes E$ we have the connection $\tilde{\nabla}$ which maps a section $L \in \Gamma(End(E))$, that is a smooth bundle map $L : E \longrightarrow E$, to

$$\tilde{\nabla}(L)(\phi) = \nabla(L\phi) - L(\nabla\phi)$$

for any $\phi \in \Omega^0(E)$.

Given connections ∇ on E and ∇' on E' , there exist naturally defined connections $\nabla \oplus \nabla'$ on $E \oplus E'$ and $\nabla \otimes \nabla'$ on $E \otimes E'$ where the latter is defined by

$$(\nabla \otimes \nabla')(\phi \otimes \phi') = (\nabla\phi) \otimes \phi' + \phi \otimes (\nabla'\phi')$$

Finally, given a connection $\nabla : \Omega^0(E) \longrightarrow \Omega^1(E)$ we can extend it to a **generalized de Rham sequence**

$$\Omega^0(E) \xrightarrow{d^\nabla} \Omega^1(E) \xrightarrow{d^\nabla} \Omega^2(E) \xrightarrow{d^\nabla} \dots$$

where we define d^∇ on $\phi \in \Omega^p(E)$ by defining what it does on a $p + 1$ -tuple of tangent vectors $V_0, \dots, V_p \in T_p M$

$$\begin{aligned} d^\nabla \phi(V_0, \dots, V_p) = & \sum_{j=0}^p (-1)^j \nabla_{V_j}(\phi(V_0, \dots, \hat{V}_j, \dots, V_p)) \\ & + \sum_{i < j} (-1)^{i+j} \phi([V_i, V_j], V_0, \dots, \hat{V}_i, \dots, \hat{V}_j, \dots, V_p) \end{aligned}$$

Here, we used the fact that vectorfields on M form a Lie algebra. For vector fields $X = \sum_{i=1}^d X_i \frac{\partial}{\partial x_i}$ and $Y = \sum_{j=1}^d Y_j \frac{\partial}{\partial x_j}$ the Lie bracket is defined to be the vectorfield

$$[X, Y] = \sum_{i,j=1}^d X_j \frac{\partial Y_i}{\partial x_j} \frac{\partial}{\partial x_i} - Y_j \frac{\partial X_i}{\partial x_j} \frac{\partial}{\partial x_i}$$

The classical de Rham sequence was shown to be a complex, that is, $d \circ d = 0$. A similar result does not hold in general for the de Rham sequence associated to a connection. In fact, the composition

$$d^\nabla \circ d^\nabla : \Omega^0(E) \longrightarrow \Omega^2(E)$$

deserves special attention.

Definition 5.3 *The curvature of a connection ∇ is the 2-form*

$$R^\nabla \in \Omega^2(\text{End}(E))$$

with values in $\text{End}(E)$ is defined for $V, W \in \Gamma(TM)$ by the rule

$$R_{V,W}^\nabla = \nabla_V \nabla_W - \nabla_W \nabla_V - \nabla_{[V,W]}$$

Exercise 5.4 *Show that on $\Omega^0(E)$ we have the equality*

$$d^\nabla \circ d^\nabla = R^\nabla$$

*We call a connection **flat** if its curvature $R^\nabla = 0$.*

5.1 Levi-Civita connection.

We will define suitable metrics on vectorbundles (E, π, M) .

Definition 5.5 A bundle metric on (E, π, M) is given by a family of scalar products on the fibers E_p , depending smoothly on $p \in M$.

Exercise 5.6 Prove the following results completely analogous to the proofs given for differentiable manifolds.

1. Every vectorbundle (E, π, M) can be equipped with a bundle metric.
2. Every vectorbundle (E, π, M) of rank n with bundle metric has structure group $O_n(\mathbb{R})$.

In particular, there exist bundle charts (f, U) with

$$f : \pi^{-1}(U) \longrightarrow U \times \mathbb{R}^n$$

with the property that if $\{e_1, \dots, e_n\}$ is an orthonormal basis of \mathbb{R}^n , then $\{f^{-1}(x, e_1), \dots, f^{-1}(x, e_n)\}$ is an orthonormal basis for E_x for all $x \in U$.

Such a bundle chart is called a **metric bundle chart**. We can use a bundle metric to restrict connections.

Definition 5.7 Let E be a vectorbundle on a differentiable manifold M with bundle metric $\langle \cdot, \cdot \rangle$. A connection ∇ on E is called **metric** (or, **Riemannian**) if

$$d\langle \phi_1, \phi_2 \rangle = \langle \nabla \phi_1, \phi_2 \rangle + \langle \phi_1, \nabla \phi_2 \rangle$$

By this we mean that if $V \in T_p M$ then

$$X\langle \phi_1, \phi_2 \rangle = \langle \nabla_X \phi_1, \phi_2 \rangle + \langle \phi_1, \nabla_X \phi_2 \rangle$$

Proposition 5.8 On every vectorbundle (E, π, M) one can construct metric connections.

Proof. Again, this follows from a partition of unity argument using the fact that convex combinations of metric connections are metric connections. \square

The tangent bundle TM is a special vectorbundle. On the tangent bundle there exists a canonical metric connection, the Levi-Civita connection.

Tullio Levi-Civita

Born : 29 march 1873 in Padua (Italy)

Died : 29 december 1941 in Rome (Italy)



Tullio Levi-Civita is best known for his work on the absolute differential calculus with its applications to the theory of relativity. Levi-Civita took his degree at the University of Padua where one of his teachers was Ricci with whom Levi-Civita was to collaborate. Levi-Civita was appointed to the Chair of Mechanics at Padua in 1898, a post which he was to hold for 20 years. In 1918 he was appointed to the Chair of Mechanics at Rome where he spent another 20 years until removed from office by the discrimination policies of the government (he was of Jewish descent). Levi-Civita is best known for his work on the absolute differential calculus with its applications to the theory of relativity. In 1887 he published a famous paper in which he developed the calculus of tensors, following on the work of Christoffel, including covariant differentiation (connections). In 1900 he published, jointly with Ricci, the theory of tensors "Méthodes de calcul différentiel absolu et leurs applications" in a form which was used by Einstein 15 years later. Weyl was to take up Levi-Civita's ideas and make them into a unified theory of gravitation and electromagnetism. Levi-Civita's work was of extreme importance in the theory of relativity, and he produced a series of papers treating elegantly the problem of a static gravitational field. In 1933 he contributed to Dirac's equations of quantum theory. Levi-Civita, like Volterra and many other Italian scientists, were strongly and actively opposed to Fascism. After he was dismissed from his post the blow soon told on his health and he developed severe heart problems. He died of a stroke.

Theorem 5.9 *On a Riemannian manifold, there is precisely one metric connection ∇ on the tangentbundle TM such that for all vectorfield V, W we have*

$$\nabla_V W - \nabla_W V = [V, W]$$

*This **Levi-Civita connection** of M is determined by the formula*

$$\begin{aligned} \langle \nabla_X Y, Z \rangle = & \frac{1}{2}(X\langle Y, Z \rangle - Z\langle X, Y \rangle + Y\langle Z, X \rangle \\ & - \langle X, [Y, Z] \rangle + \langle Z, [X, Y] \rangle + \langle Y, [Z, X] \rangle) \end{aligned}$$

Proof. If a connection ∇ is metric it has to satisfy

$$\begin{aligned} X\langle Y, Z \rangle &= \langle \nabla_X Y, Z \rangle + \langle Y, \nabla_X Z \rangle \\ Y\langle Z, X \rangle &= \langle \nabla_Y Z, X \rangle + \langle Z, \nabla_Y X \rangle \\ Z\langle X, Y \rangle &= \langle \nabla_Z X, Y \rangle + \langle X, \nabla_Z Y \rangle \end{aligned}$$

If we assume moreover that ∇ satisfies the requirement that

$$\nabla_V W - \nabla_W V = [V, W]$$

this implies that

$$\begin{aligned} X\langle Y, Z \rangle - Z\langle X, Y \rangle + Y\langle Z, X \rangle = \\ 2(\langle \nabla_X Y, Z \rangle - \langle X, [Y, Z] \rangle - \langle [X, Y], Z \rangle - \langle Y, [X, Z] \rangle) \end{aligned}$$

which proves uniqueness of such a connection. Because $\langle \cdot, \cdot \rangle$ is non-degenerate, the formula defines $\nabla_X Y$ uniquely for every X, Y and some calculations then show that this ∇ is indeed a metric connection. \square

5.2 The Yang-Mills connections.

In this subsection we will describe special metric connections on an arbitrary vectorbundle (E, π, M) of rank n with bundle metric $\langle \cdot, \cdot \rangle$. Recall that $End E$ is the vectorbundle of endomorphisms of E , it is a vectorbundle with fibers isomorphic to $\mathfrak{gl}_n(\mathbb{R})$. With $Ad E$ we will denote the subbundle with fibers isomorphic to $\mathfrak{o}_n(\mathbb{R})$, that is, vectorbundle endomorphisms of E which are fiberwise given by skew symmetric matrices.

Lemma 5.10 *Write the metric connection ∇ as*

$$\nabla = d + A \text{ with } A \in \Omega^1(End E)$$

Then, actually $A \in \Omega^1(Ad E)$. That is, for every $X \in TM$ we have that $A(X)$ is a skew symmetric $n \times n$ matrix.

Proof. A metric bundle chart (f, U) gives sections $\{\mu_1, \dots, \mu_n\}$ on U that form an orthonormal basis in every fiber E_x for $x \in U$, that is

$$\langle \mu_i(x), \mu_j(x) \rangle = \delta_{ij}$$

Moreover, in the bundle chart the μ_i are constant and hence for the exterior derivative defined by the chart we have

$$d\mu_i = 0$$

Now let $i \neq j$ and $X \in T_x M$, then it follows that

$$\begin{aligned} 0 &= X \langle \mu_i, \mu_j \rangle &&= \langle A(X) \mu_i, \mu_j \rangle + \langle \mu_i, A(X) \mu_j \rangle \\ &= \langle \sum_{k=1}^n A(X)_{ik} \mu_k, \mu_j \rangle + \langle \mu_i, \sum_{k=1}^n A(X)_{jk} \mu_k \rangle \\ &= A(X)_{ij} + A(X)_{ji} \end{aligned}$$

□

Lemma 5.11 *Let $\nabla = d + A$ a metric connection on E and R^∇ the curvature of ∇ , then*

$$R^\nabla \in \Omega^2(\text{Ad } E)$$

Proof. If we write $A = \sum_{k=1}^n A_k dx_k$, then one computes that

$$R_{\partial_i, \partial_j}^\nabla = \frac{1}{2} \left(\frac{\partial A_j}{\partial x_i} - \frac{\partial A_i}{\partial x_j} + [A_i, A_j] \right) dx_i \wedge dx_j$$

which is clearly skew symmetric. □

Given metrics on M and E there are naturally induced metrics on all the associated bundles such as $\wedge^p T^*M \otimes E$. A metric connection on E give metric connections on these bundles. In particular, if M is compact and oriented, the pointwise inner product gives an inproduct on $\Omega^p(E)$ by defining

$$(\phi_1, \phi_2) = \int_M \langle \phi_1, \phi_2 \rangle * (1)$$

The maps d^∇ defined before then have formal adjoints

$$\Omega^0(E) \xleftarrow{\delta^\nabla} \Omega^1(E) \xleftarrow{\delta^\nabla} \Omega^2(E) \xleftarrow{\delta^\nabla} \dots$$

with the property that

$$(d^\nabla \phi, \psi) = (\phi, \delta^\nabla \psi)$$

for all $\phi \in \Omega^p(E)$ and $\psi \in \Omega^{p+1}(E)$.

We want to make all this a bit more precise in the case of interest to us, that is if we replace E in the above by the vectorbundle $\text{Ad } E$.

We now want to define a scalar product on $\Omega^p(\text{Ad } E)$. If $A, B \in \mathfrak{o}_n(\mathbb{R})$, then

$$A.B = -\text{tr}(AB)$$

defines a positive definite scalar product on $\mathfrak{o}_n(\mathbb{R})$ called (the negative of) the **Killing form** of the Lie algebra $\mathfrak{o}_n(\mathbb{R})$.

On p -forms we already defined a pointwise scalar product. Recall that if $\omega_1, \omega_2 \in \wedge^p T_x^* M$ then

$$\langle \omega_1, \omega_2 \rangle = *(\omega_1 \wedge *\omega_2)$$

By combining we then have a scalar product on $\mathfrak{o}_n(\mathbb{R}) \otimes \wedge^p T_x^* M$ by the rule

$$\langle A \otimes \omega_1, B \otimes \omega_2 \rangle = A.B \langle \omega_1, \omega_2 \rangle$$

which we can extend by linearity.

If M is now a compact and oriented manifold, this in turn yields a scalar product on $\Omega^p(Ad E)$

$$(\mu_1 \otimes \omega_1, \mu_2 \otimes \omega_2) = \int_M \langle \mu_1 \otimes \omega_1, \mu_2 \otimes \omega_2 \rangle * (1)$$

Definition 5.12 *Let M be a compact oriented Riemannian manifold and ∇ a metric connection on a vectorbundle E of rank n .*

*The **Yang-Mills functional** applied to ∇ is then*

$$YM(\nabla) = (R^\nabla, R^\nabla) = \int_M \langle R^\nabla, R^\nabla \rangle * (1)$$

where $R^\nabla \in \Omega^2(Ad E)$ is the curvature of ∇ .

Recall that the space of all connections on E is an affine space, the difference of two connections being an element of $\Omega^1(End E)$. Likewise, the space of all metric connections on E (which we will denote with \mathcal{C}) is an affine space, the difference of two metric connections being an element of $\Omega^1(Ad E)$. We have a functional

$$YM : \mathcal{C} \longrightarrow \mathbb{R}^+$$

and as always we are interested in the critical points of this functional. For this we have to compute variations of the form for $\nabla + tB$ where $B \in \Omega^1(Ad E)$. One can compute

$$\frac{d}{dt} YM(\nabla + tB) |_{t=0} = 2 \int_M \langle \nabla B, R^\nabla \rangle * (1) = 2(B, \delta^\nabla R^\nabla)$$

with δ^∇ defined as before replacing E by $Ad E$.

Therefore, ∇ is a critical point of the Yang-Mills functional on metric connections on E if and only if $\delta^\nabla R^\nabla = 0$.

Definition 5.13 *Let M be a compact oriented manifold and ∇ a metric connection on a vectorbundle E . Then, ∇ is said to be a **Yang-Mills connection** iff*

$$\delta^\nabla R^\nabla = 0$$

For $\nabla = d + A$ with $A \in \Omega^1(Ad E)$ we have for all $\mu \in \Omega^{p-1}(Ad E)$ and all $\nu \in \Omega^p E$ that

$$(\nu, d\mu + \sum_i A_i dx_i \wedge \mu) = (\delta\nu, \mu) - \sum_i (A_i \nu, dx_i \wedge \mu)$$

since A is skew symmetric. If we specialize to the case $p = 2$ then we know that the Hodge-star operator satisfies $** = id$. Now, the generalized Hodge star operator

$$* : \Omega^2(Ad E) \longrightarrow \Omega^{d-2}(Ad E)$$

operates on the differential form part as the Hodge star and leaves the $\mathfrak{o}_n(\mathbb{R})$ part invariant, that is,

$$*(\phi \otimes \omega) = (\phi \otimes *\omega)$$

for $\phi \in \Gamma(Ad E)$ and $\omega \in \Omega^2(M)$. Now we have seen that $\delta = (-1)^{d+1} * d*$. Moreover, A_i and $*$ commute since A_i operates on the $Ad E$ part and $*$ on the form part whence $*A_i* = A_i$. But then we have the following expression for δ^∇ .

$$\delta^\nabla = - * (d + A)* = - * \nabla *$$

for even dimension of M .

Again, let E be a vectorbundle with bundle metric. With $Aut(E)$ we denote the fiber bundle with fiber over $p \in M$ the group of orthogonal self transformations of the fiber E_p .

Definition 5.14 *A gauge transformation is a section of $Aut(E)$. The group \mathcal{G} of gauge transformations is called the gauge group of the metric bundle E .*

The groupstructure is given by fiberwise matrixmultiplication. An element $s \in \mathcal{G}$ operates on the space of metric connections ∇ on E via

$$s^*(\nabla) = s^{-1} \circ \nabla \circ s$$

That is, for any $\phi \in \Gamma(E)$ we have

$$s^*(\nabla)\phi = s^{-1}\nabla(s\phi)$$

and for $\nabla = d + A$ we obtain

$$s^*(A) = s^{-1}ds + s^{-1}As$$

Further, the curvature R^∇ of ∇ transforms via

$$s^*(R^\nabla) = s^{-1} \circ R^\nabla \circ s$$

and as an orthogonal map on E is an isometry of $\langle \cdot, \cdot \rangle$ we have that

$$\langle s^*R^\nabla, s^*R^\nabla \rangle = \langle R^\nabla, R^\nabla \rangle$$

Using these facts we can prove

Theorem 5.15 *The Yang-Mills functional is invariant under the action of the gauge group \mathcal{G} . Therefore, if ∇ is a critical point, that is if ∇ is a Yang-Mills connection, so is $s^*\nabla$ for $s \in \mathcal{G}$. Therefore, the space of Yang-Mills connections on a given vector bundle E of rank $n \geq 2$ is either empty or infinite dimensional.*

Of course the above can be generalized to vectorbundles with different structure groups. If the structure group of E is a Lie group G , we let $Aut(E)$ be the bundle with fiber given by G and operating on E by conjugation. The group of sections of $Aut(E)$ will again be called the gauge group.

For those of you who have already heard about gauge theories in physics, let s briefly indicate the mathematical relationship with the above.

The prototype of all gauge theories is Maxwell's theory of electro-magnetism. From the geometrical point of view, the electromagnetic **potential** a_i ($1 \leq i \leq 4$) defines a connection for a vectorbundle with structure group $U_1(\mathbb{C})$ over Minkowski space-time M . This is a semi-Riemannian manifold, the difference being that the inproducts are not positive definite but have locally diagonal forms

$$\begin{bmatrix} 1 & 0 & 0 & 0 \\ 0 & 1 & 0 & 0 \\ 0 & 0 & 1 & 0 \\ 0 & 0 & 0 & -1 \end{bmatrix}$$

and one can repeat much of the theory in this setting as again we have the property that if $\langle v, w \rangle = 0$ for all w then $v = 0$. Anyway, the electro-magnetic **field** is the corresponding curvature

$$f_{ij} = \frac{\partial a_j}{\partial x_i} - \frac{\partial a_i}{\partial x_j}$$

Maxwell's equations in vacuum take the form

$$df = 0 \text{ and } \delta f = 0$$

where f is viewed as a 2-form, d is the exterior derivative and δ is its formal adjoint, this time with respect to the Minkowski metric.

Non-abelian gauge theories are obtained by replacing $U_1(\mathbb{C})$ with a compact non-Abelian Lie group G such as $SU_n(\mathbb{C})$. A potential is then a connection ∇ over Minkowski space, with components ∇_i in the Lie algebra of G . The field is then the corresponding curvature with components

$$R_{ij}^\nabla = \frac{\partial \nabla_i}{\partial x_j} - \frac{\partial \nabla_j}{\partial x_i} + [\nabla_i, \nabla_j]$$

The most straightforward generalizations of Maxwell's equations are the **Yang-Mills equations**

$$d^\nabla R^\nabla = 0 \text{ and } \delta^\nabla R^\nabla = 0$$

We should recall that for the curvature of a connection we always have $d^\nabla R^\nabla = 0$, this is the so called **Bianchi identity**.

Gauge theories have an infinite-dimensional symmetry group given by functions from M to G and all physical properties are invariant under this gauge group. Moreover, to specify a physical theory the usual procedure is to define a **Lagrangian** or action. This is a functional of the various fields obtained by integrating over M a Lagrangian density. For a scalar field theory where the only field is a scalar function ϕ , the simplest Lagrangian is

$$L(\phi) = \int_M \| \text{grad } \phi \|^2 dx$$

where the norm and volume form are those of Minkowski space M . For Yang-Mills theory the Lagrangian is

$$L(\nabla) = \int_M \| R^\nabla \|^2 dx$$

where the norm here also uses an invariant metric on G . Note that this is just our Yang-Mills functional.

5.3 Four dimensional manifolds

In this subsection we give a short introduction to the results of Donaldson on the classification of simply connected differentiable 4-manifolds. Clearly, we cannot give too much details.

Let us begin by pointing out the special features of dimension 4 to Yang-Mills connections. As always, we suppose that M is a compact oriented Riemann manifold, then the Hodge star operator acts on $\wedge^2 T_p^* M$ for any $p \in M$

$$* : \wedge^2 T_p^* M \longrightarrow \wedge^2 T_p^* M$$

and as $** = id$ we have a decomposition into eigenspaces corresponding to the eigenvalues ± 1 .

$$\wedge^2 T_p^* M = \Lambda^+ \oplus \Lambda^-$$

Both spaces are of dimension 3 and in normal coordinates Λ^+ is generated by

$$\begin{aligned} dx_1 \wedge dx_2 + dx_3 \wedge dx_4 \\ dx_1 \wedge dx_4 + dx_2 \wedge dx_3 \\ dx_1 \wedge dx_3 - dx_2 \wedge dx_4 \end{aligned}$$

and Λ^- by

$$\begin{aligned} dx_1 \wedge dx_3 + dx_2 \wedge dx_4 \\ dx_1 \wedge dx_2 - dx_3 \wedge dx_4 \\ dx_1 \wedge dx_4 - dx_2 \wedge dx_3 \end{aligned}$$

The elements of Λ^+ are called **selfdual**, those of Λ^- **anti-selfdual**.

Definition 5.16 *A connection ∇ over an oriented four dimensional Riemannian manifold is called an **instanton** (resp. *anti-instanton*) if its curvature R^∇ is a selfdual 2-form (resp. an anti-selfdual 2-form).*

Theorem 5.17 *Every (anti)-instanton connection is a Yang-Mills connection.*

Proof. We have to prove that $\delta^\nabla R^\nabla = 0$. By the expression $\delta^\nabla = - * d^\nabla *$ in even dimensions this is equivalent to

$$d^\nabla * R^\nabla = 0$$

Now assume that ∇ is an instanton or anti-instanton, then

$$R^\nabla = \pm * R^\nabla$$

but then the above equation becomes

$$d^\nabla **R^\nabla = 0$$

and as $** = id$ we obtain

$$d^\nabla R^\nabla = 0$$

which is satisfied because it is the Bianchi identity. □

In the case of a vectorbundle with structure group $SU_n(\mathbb{C})$ one has a converse to this result.

Theorem 5.18 *Let E be a vectorbundle with structure group $SU_n(\mathbb{C})$ over a compact oriented four manifold M . A connection ∇ on E gives an absolute minimum for the Yang-Mills functional precisely if ∇ is instanton or anti-instanton (depending on a topological invariant of E).*

If M is a compact differentiable four manifold, then there is a natural pairing, which is called the **intersection form** of M

$$\Gamma : H_{dR}^2(M, \mathbb{R}) \times H_{dR}^2(M, \mathbb{R}) \longrightarrow \mathbb{R}$$

defined by

$$(\alpha, \beta) \mapsto \int_M \alpha \wedge \beta$$

Simon Kirwan Donaldson

Born : 20 august 1957 in Cambridge (England)



Simon Donaldson's secondary school education was at Sevenoaks School in Kent which he attended from 1970 to 1975. He then entered Pembroke College, Cambridge where he studied until 1980, receiving his B.A. in 1979. One of his tutors at Cambridge described him as a very good student but certainly not the top student in his year. Apparently he would always come to his tutorials carrying a violin case. In 1980 Donaldson began postgraduate work at Worcester College, Oxford, first under Nigel Hitchin's supervision and later under Atiyah's supervision. In 1982, when he was a second-year graduate student, Simon Donaldson proved a result that stunned the mathematical world. Together with the important work of Michael Freedman, Donaldson's result implied that there are "exotic" 4-spaces, i.e. 4-dimensional differentiable manifolds which are topologically but not differentiably equivalent to the standard Euclidean 4-space R^4 . What makes this result so surprising is that $n = 4$ is the only value for which such exotic n -spaces exist. These exotic 4-spaces have the remarkable property that (unlike R^4 they contain compact sets which cannot be contained inside any differentiably embedded 3-sphere. After being awarded his doctorate from Oxford in 1983, Donaldson was appointed a Junior Research Fellow at All Souls College, Oxford. He spent the academic year 1983-84 at the Institute for Advanced Study at Princeton, After returning to Oxford he was appointed Wallis Professor of Mathematics in 1985, a position he continues to hold. Donaldson has received many honours for his work. He received the Junior Whitehead Prize from the London Mathematical Society in 1985. In the following year he was elected a Fellow of the Royal Society and, also in 1986, he received a Fields Medal at the International Congress at Berkeley. Atiyah describes the contribution which led to Donaldson's award of a Fields Medal : "When Donaldson produced his first few results on 4-manifolds, the ideas were so new and foreign to geometers and topologists that they merely gazed in bewildered admiration. Slowly the message has gotten across and now Donaldson's ideas are beginning to be used by others in a variety of ways. ... Donaldson has opened up an entirely new area; unexpected and mysterious phenomena about the geometry of 4-dimensions have been discovered. Moreover the methods are new and extremely subtle, using difficult nonlinear partial differential equations. On the other hand, this theory is firmly in the mainstream of mathematics, having intimate links with the past, incorporating ideas from theoretical physics, and tying in beautifully with algebraic geometry."

A major result of Donaldson (the importance of which will become clear in the

next subsection) is

Theorem 5.19 *Let M be a compact oriented differentiable simply connected 4-manifold with positive definite intersection form. Then, for a suitable basis of $H_{dR}^2(M, \mathbb{R})$, the intersection form is represented by \pm the identity matrix.*

Proof. (sketch!)

The crucial ingredient in the proof of Donaldson's theorem is the moduli space \mathcal{M} of instantons ∇ on a vectorbundle over M with structure group $SU_2(\mathbb{C})$ with so-called topological charge

$$\frac{-1}{8\pi} \int_M \text{tr}(R^\nabla \wedge \nabla) = 1$$

for the curvature R^∇ of the connection.

The topological charge is a topological invariant of the bundle (it is the negative of the second Chern class of the bundle) and does not depend on the choice of the $SU_2(\mathbb{C})$ -connection.

In order to construct the moduli space of instantons, one identifies instantons that are gauge equivalent, that is, differ only by a gauge transformation.

Donaldson then showed that under the stated assumptions on M , the moduli space \mathcal{M} is an oriented five dimensional manifold with a finite number of point singularities, at least for generic Riemannian metrics on M .

Neighborhoods of these singular points are cones over the complex projective space $\mathbb{P}^2(\mathbb{C})$ (which is a differentiable 4-manifold) and M is the boundary of \mathcal{M} . Deleting neighborhoods of these singular points, one obtains a differentiable oriented five dimensional manifold with a boundary consisting of M and some copies of $\mathbb{P}^2(\mathbb{C})$. In the terminology of algebraic topology, this says that M is 'cobordant' to a union of $\mathbb{P}^2(\mathbb{C})$ and hence has the same intersection form as this union of $\mathbb{P}^2(\mathbb{C})$.

Finally, one computes that $H_{dR}^2(\mathbb{P}^2(\mathbb{C}), \mathbb{R}) = \mathbb{R}$ with intersection form 1, which then implies the result.

Clearly, the main part of the proof goes into deriving the stated properties of the moduli space \mathcal{M} . □

Donaldson then went on to use the topology and geometry of these moduli spaces to define new invariants for differentiable four dimensional manifolds, the so-called **Donaldson polynomials**. These polynomials greatly enhanced the understanding of the topology of four dimensional differentiable manifolds.

5.4 Exotic structures on \mathbb{R}^4 .

In dimension ≤ 3 we have seen that every manifold admits a unique differentiable structure. In this subsection we will see that Donaldson's result combined

with Freedman's classification of simply connected topological four dimensional manifolds shows that this is no longer the case in dimension 4. Neither does every topological manifold admit a differentiable structure nor is such a structure uniquely determined when it exists. First we recall the important topological results of Freedman

Michael Hartley Freedman

Born : 21 april 1951 in Los Angeles (USA)



Michael Freedman entered the University of California at Berkeley in 1968 and continued his studies at Princeton University in 1969. He was awarded a doctorate by Princeton in 1973. Freedman was promoted to associate professor at San Diego in 1979. He spent the year 1980/81 at the Institute for Advanced Study at Princeton returning to the University of California at San Diego where he was promoted to professor on 1982. He holds this post in addition to the Charles Lee Powell Chair of Mathematics which he was appointed to in 1985. Freedman was awarded a Fields Medal in 1986 for his work on the Poincaré conjecture. The Poincaré conjecture, one of the famous problems of 20th-century mathematics, asserts that a simply connected closed 3-dimensional manifold is a 3-dimensional sphere. The higher dimensional Poincaré conjecture claims that any closed n -manifold which is homotopy equivalent to the n -sphere must be the n -sphere. When $n = 3$ this is equivalent to the Poincaré conjecture. Smale proved the higher dimensional Poincaré conjecture in 1961 for n at least 5. Freedman proved the conjecture for $n = 4$ in 1982 but the original conjecture remains open. Michael Freedman has not only proved the Poincaré conjecture for 4-dimensional topological manifolds, thus characterizing the sphere S^4 , but has also given us classification theorems, easy to state and to use but difficult to prove, for much more general 4-manifolds. The simple nature of his results in the topological case must be contrasted with the extreme complications which are now known to occur in the study of differentiable and piecewise linear 4-manifolds. Freedman's 1982 proof of the 4-dimensional Poincaré conjecture was an extraordinary tour de force. His methods were so sharp as to actually provide a complete classification of all compact simply connected topological 4-manifolds, yielding many previously unknown examples of such manifolds, and many previously unknown homeomorphisms between known manifolds.

To begin, a simply connected four dimensional manifold can be oriented. Using this orientation one can define, analogous to the intersection form on the middle de Rham cohomology for a differentiable 4-manifold, an intersection form on the middle homology group $H_2(M, \mathbb{Z})$ in such a way that the intersection of two transversal, oriented surfaces can be counted as an integer.

This gives a symmetric bilinear form μ on $H_2(M, \mathbb{Z})$ and Poincaré duality states that this form is unimodular. That is, if μ is written as a matrix in $M_r(\mathbb{Z})$ then the determinant of this matrix is ± 1 . If the determinant is one we call μ definite, when it is -1 we call μ indefinite.

A classical result, proved by Whitehead in 1949 says that μ determines M up to homotopy type.

John Henry Constantine Whitehead

Born : 11 november 1904 in Madras (India)

Died : 8 may 1960 in Princeton (USA)



Henry Whitehead was born in India but lived in England from the age of two. While at Oxford Whitehead met Veblen who arranged a scholarship which enabled him to study for a Ph.D. at Princeton. Whitehead was awarded his doctorate from Princeton in 1930 for a dissertation entitled 'The Representation of Projective Spaces.' Whitehead's joint work with his doctoral supervisor Veblen led to 'The Foundations of Differential Geometry' (1932), now considered a classic. It contains the first proper definition of a differentiable manifold. Whitehead returned to England, worked at the Admiralty during the War, then he was appointed to a chair at Oxford. Soon after his return to England he wrote another major work on differential geometry 'On the Covering of a Complete Space by the Geodesics Through a Point' (1935). Whitehead's interests turned more towards topology and he collaborated with Lefschetz. In this area he is best remembered for his work on homotopy equivalence. He also studied Stiefel manifolds and set up a school of topology at Oxford.

Theorem 5.20 *Two compact simply connected 4-manifolds are homotopy equivalent if and only if their intersection forms are equivalent.*

Recall that two symmetric bilinear forms on \mathbb{Z}^r are equivalent if there is a matrix $A \in GL_r(\mathbb{Z})$ such that $A^{tr}\mu_1A = \mu_2$. Important invariants of integral quadratic forms are the rank r and the signature which is $e - 2q$ where q is the maximal dimension of a subspace of \mathbb{R}^r on which μ is negative definite. We say that a form μ is of **type II** if $\mu(x, x)$ is even for all $x \in \mathbb{Z}^r$ and is of **type I** otherwise. One can show that the signature of a type II form must be a multiple of 8. Indefinite unimodular symmetric forms are completely determined up to equivalence by their rank and signature.

$$\begin{aligned} \text{type I : } \quad \mu &\equiv \langle 1 \rangle \oplus \dots \oplus \langle 1 \rangle \oplus \langle -1 \rangle \oplus \dots \oplus \langle -1 \rangle \\ \text{type II : } \quad \mu &\equiv H \oplus \dots \oplus H \oplus E_8 \oplus \dots \oplus E_8 \end{aligned}$$

where $\langle 1 \rangle$ and $\langle -1 \rangle$ are the two possible rank one forms, $H = \begin{bmatrix} 0 & 1 \\ 1 & 0 \end{bmatrix}$ and

$$E_8 = \begin{bmatrix} 2 & 1 & 0 & 0 & 0 & 0 & 0 & 0 \\ 1 & 2 & 1 & 0 & 0 & 0 & 0 & 0 \\ 0 & 1 & 2 & 1 & 0 & 0 & 0 & 0 \\ 0 & 0 & 1 & 2 & 1 & 0 & 0 & 0 \\ 0 & 0 & 0 & 1 & 2 & 1 & 1 & 0 \\ 0 & 0 & 0 & 0 & 1 & 2 & 0 & 0 \\ 0 & 0 & 0 & 0 & 1 & 0 & 2 & 1 \\ 0 & 0 & 0 & 0 & 0 & 0 & 1 & 2 \end{bmatrix}$$

which is the matrix describing the root system for the exceptional Lie group E_8 . Clearly, the form being indefinite forces that in for type I both $\langle 1 \rangle$ and $\langle -1 \rangle$ appear and for type II that at least one copy of H appears.

Definite unimodular symmetric forms are a different matter altogether and form one of the difficult classical fields of mathematics. Let $N(r)$ be the number of inequivalent unimodular type II positive definite forms of rank r , then one has proved that

r	8	16	24	32	40
$N(r)$	1	2	24	$\geq 10^7$	$\geq 10^{51}$

In view of Whitehead's theorem we can ask whether an unimodular form appears as the intersection form of a simply connected 4-dimensional topological manifold and if a form occurs how many homeomorphism classes of manifolds carry the same form.

For the trivial form, the last question is the four dimensional Poincaré conjecture. Recall that the **Poincaré conjecture** asserts that there is no n -dimensional

manifold homotopic but not homeomorphic to S^n . Recall that the Poincaré conjecture for $n \geq 5$ was proved by Smale in 1961.

Stephen Smale

Born : 15 july 1930 in Flint, Michigan (USA)

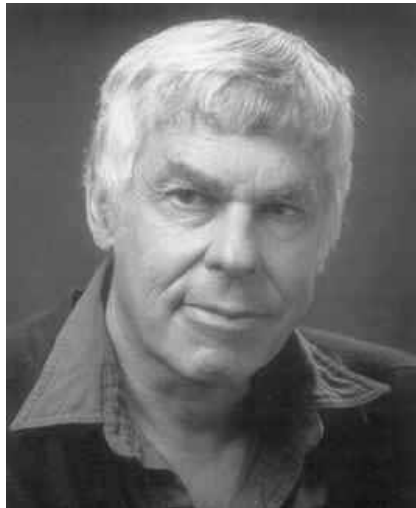

Stephen Smale worked for his doctorate at the University of Michigan, Ann Arbor under R Bott's supervision and he was awarded his Ph D in 1957 for the thesis 'Regular Curves on Riemannian Manifolds.' In his thesis he generalized results proved by Whitney in 1937 for curves in the plane to curves on an n -manifold. In 1958 Smale learned about Pontryagin's work on structurally stable vector fields and he began to apply topological methods to study these problems. In 1960 Smale was appointed an associate professor of mathematics at the University of California at Berkeley, moving to a professorship at the University of Columbia the following year. In 1964 he returned to a professorship at the University of California at Berkeley where he has spent the main part of his career. He retired from Berkeley in 1995 and took up a post as professor at the City University of Hong Kong. Smale was awarded a Fields Medal at the International Congress at Moscow in 1966. The work which led to this award was his prove of the Poincaré conjecture for dimension $n \geq 5$. Another area in which Smale has made a very substantial contribution is in Morse theory which he has applied to multiple integral problems. In fact Smale attacked the generalized Poincaré conjecture using Morse theory. Another discovery of Smale's related to strange attractors. An attractor in classical mechanics is a geometrical way of describing the behavior of a dynamical system. There are three classical attractors, a point which characterizes a steady state system, a closed loop which characterizes a periodic system, and a torus which combines several cycles. Smale discovered strange attractors which lead to chaotic dynamical systems. Strange attractors have detailed structure on all scales of magnification and were one of the early fractals to be studied.

Simply connected four dimensional manifolds divide into two classes : those which have no spin structure and have intersection forms of type I, the homeomorphism classes of which we will denote by MAN_I , and those which do have a spin structure

and an intersection form of type II, the homeomorphism classes of which we denote by MAN_{II} .

With \mathbb{F}_I we denote the equivalence classes of unimodular symmetric forms of type I and with \mathbb{F}_{II} those of type II. The important result which Freedman proved in 1982 can now be stated as.

Theorem 5.21 *Taking the intersection form of a manifold gives a map*

$$\text{MAN}_{II} \longrightarrow \mathbb{F}_{II}$$

which is a bijection and a map

$$\text{MAN}_I \longrightarrow \mathbb{F}_I$$

which is exactly two-to-one and surjective.

Thus, every unimodular form is the intersection form of a simply connected topological 4-dimensional manifold. This manifold is unique up to homeomorphism in the type II case and there are exactly two homeomorphism classes with the same intersection form in the type I case.

This result immediately implies that there exist 4-dimensional manifolds having no differential structure. This follows either from Donaldson's result or from a much older result which Rochlin proved in 1952.

Theorem 5.22 *Let M be a compact simply connected 4-dimensional differentiable manifold of type II. Then, the signature of its intersection form is a multiple of 16.*

If we combine this restriction with the results of Freedman and Donaldson (the theorem of Donaldson removes the impenetrable jungle of positive definite symmetric forms from the study of differentiable manifolds !) we get the following simple list of homeomorphism classes of simply connected differentiable 4-manifolds. As in the case of surfaces we can define the connected sum of two 4-dimensional manifolds by cutting a ball B^3 out of each and gluing smoothly along the boundary S^3 .

Theorem 5.23 *If M is a simply connected differentiable 4-dimensional manifold, then M is homeomorphic to either*

1. *the sphere S^4 , or*
2. *a connected sum of the form*

$$\mathbb{P}^2(\mathbb{C}) \# \dots \# \mathbb{P}^2(\mathbb{C}) \# \overline{\mathbb{P}^2(\mathbb{C})} \# \dots \# \overline{\mathbb{P}^2(\mathbb{C})}$$

Now take any homeomorphism

$$h : \mathbb{P}^2(\mathbb{C}) \longrightarrow \mathbb{P}^2(\mathbb{C})$$

Then the set $\mathbb{P}^2(\mathbb{C}) - h(S^2)$ is $h(\mathbb{R}^4)$ and hence clearly homeomorphic to \mathbb{R}^4 . Moreover, $h(\mathbb{R}^4)$ inherits a differentiable structure, being an open subset of the differentiable manifold $\mathbb{P}^2(\mathbb{C})$.

Start with a 4-manifold for which a certain topological invariant (the Kirby-Siebenmann invariant) vanishes but such that M cannot carry a differentiable structure by Donaldson's result. For example, the manifold

$$M = E_8 \# \mathbb{P}^2(\mathbb{C})$$

satisfies these requirements.

F. Quinn has proved in 1982 that if M is a compact topological 4-manifold with vanishing Kirby-Siebenmann invariant, then M admits a differentiable structure defined outside a finite set of points and each of these singular points is 'resolvable'.

We say that a singular point $p \in M$ is **resolvable** if there is an open neighborhood U of p such that

$$U - \{p\} \text{ is diffeomorphic to } V - h(S^2)$$

where $h : \mathbb{P}^2(\mathbb{C}) \longrightarrow \mathbb{P}^2(\mathbb{C})$ is an homeomorphism and V is an open neighborhood of $h(S^2)$ in $\mathbb{P}^2(\mathbb{C})$. If you know some algebraic geometry of (complex) surfaces, then this process is very much like the process of blowing up a point.

Let $\{p_1, \dots, p_n\}$ be the resolvable singularities of M . For each j we have neighborhoods U_j of p_j and diffeomorphisms between

$$U_j - \{p_j\} \text{ and } V_j - h_j(S^2)$$

for homeo-endomorphisms h_j on $\mathbb{P}^2(\mathbb{C})$. Observe that $V_j - h_j(S^2)$ is a neighborhood of infinity for some differentiable structure on $\mathbb{R}^4 = \mathbb{P}^2(\mathbb{C}) - h_j(S^2)$.

We claim that at least one of the

$$\mathbb{R}_j^4 = V_j - h_j(S^2)$$

is not diffeomorphic to \mathbb{R}^4 . For, consider the closed compact set

$$K_j = \mathbb{R}_j^4 - (V_j - h_j(S^2)).$$

If \mathbb{R}_j^4 is diffeomorphic to \mathbb{R}^4 , then K_j can be surrounded by a smoothly embedded S^3 lying in $V_j - h_j(S^2)$.

But then we can use the diffeomorphism to obtain a smoothly embedded S^3 in $U_j - \{p_j\}$. Then we can cut the interior of this S^3 out of M and attach a D^4 . If we can do this for every j , we would get a differentiable structure on M which is impossible by the result of Donaldson, finishing the proof of the claim.

5.5 Three dimensional manifolds

We have seen that the Yang-Mills functional exhibits special features in dimension four. There is also a functional that is well adapted to the study of three dimensional manifolds, namely the **Chern-Simons** functional.

Let M be a compact oriented three dimensional differentiable manifold. Recall that any three dimensional topological manifold is homeomorphic to a differentiable manifold and that the differentiable structure is uniquely determined.

Let G be a compact Lie group with Lie algebra \mathfrak{g} and let E be a vectorbundle over M with structure group G . We will consider G -connections ∇ , that is, connections that can be **locally** written as

$$\nabla = d + A \text{ where } A \in \Omega^1(\mathfrak{g})$$

We will assume that E is a trivial G -bundle, that is, E is isomorphic to $M \times \mathbb{R}^n$ (for some n -dimensional representation \mathbb{R}^n of G) and we assume that the connection given by the exterior derivative d preserves the G -structure. In this case, any other G -connection on E is **globally** of the form

$$\nabla = d + A$$

where A is a globally defined 1-form with values in \mathfrak{g} . Hence, the set \mathcal{C} of all G -connections is an affine space $\Omega^1(\mathfrak{g})$. Let \mathcal{G} be the corresponding **gauge group**, that is

$$\mathcal{G} = \text{Map}(M, G)$$

the set of all smooth maps from M to G with pointwise multiplication as the group operation. Then \mathcal{G} acts on the space of connections \mathcal{C} .

Precisely as in the case of the Yang-Mills functional we would like to construct a \mathcal{G} -invariant scalar-valued function f on \mathcal{C} . Such an f would be determined up to a constant which we can fix by taking the value of f at the trivial connection to be zero.

The main problem is that the quotient-space \mathcal{C}/\mathcal{G} can be shown to be not simply connected. Hence, f can only be expected to be well defined locally and globally it will be multi-valued. It will turn out that f is well defined only up to integral multiples of a constant.

Definition 5.25 *For a connection $\nabla = d + A$ with $A \in \Omega^1(\mathfrak{g})$, the **Chern-Simons functional** is defined to be*

$$CS(\nabla) = \int_M \text{Tr}(A \wedge dA + \frac{2}{3}A \wedge A \wedge A)$$

where Tr is the trace in \mathfrak{g} , that is, the negative of the Killing form.

This $CS(A)$ is a multiple of the $f(A)$ we want to construct. Observe that because A is a 1-form, the expressions $A \wedge dA$ and $A \wedge A \wedge A$ are 3-forms and hence the integral makes sense on a three dimensional manifold and we do not have to specify a Riemannian metric on M for the definition to make sense. Thus, any invariants we will construct from the Chern-Simons functional will automatically be topological invariants of M . This leads to the definition of Witten invariants.

Edward Witten

Born : 26 august 1951 in Baltimore (USA)



Edward Witten studied at Brandeis University and received his B.A. in 1971. From there he went to Princeton receiving his M.A. in 1974 and his Ph.D. in 1976. After completing his doctorate, Witten went to Harvard where he was postdoctoral fellow during session 1976-77 and then a Junior Fellow from 1977 to 1980. In September 1980 Witten was appointed professor of Physics at Princeton. He was awarded a MacArthur Fellowship in 1982 and remained as professor of Physics at Princeton until 1987 when he was appointed as a Professor in the School of Natural Sciences at the Institute for Advanced Study. Speaking at the American Mathematical Society Centennial Symposium in 1988, Witten explained the relation between geometry and theoretical physics "It used to be that when one thought of geometry in physics, one thought chiefly of classical physics - and in particular general relativity - rather than quantum physics. ... Of course, quantum physics had from the beginning a marked influence in many areas of mathematics - functional analysis and representation theory, to mention just two. ... Several important influences have brought about a change in this situation. One of the principal influences was the recognition - clearly established by the middle 1970s - of the central role of nonabelian gauge theory in elementary particle physics. The other main influence came from the emerging study of supersymmetry and string theory." In his study of these areas of theoretical physics, Witten has achieved a level of mathematics which has led him to be awarded the highest honour that a mathematician can receive, namely a Fields Medal. He received the medal at the International Congress of Mathematicians which was held in Kyoto, Japan in 1990. The first major contribution which led to Witten's Fields Medal was his simpler proof of the positive mass conjecture which had led to a Fields Medal for Yau in 1982. In recent years, Witten focused

his attention on topological quantum field theories. These correspond to Lagrangians, formally giving manifold invariants. Witten described these in terms of the invariants of Donaldson and Floer (extending the earlier ideas of Atiyah) and generalized the Jones knot polynomial.

Let \mathcal{G}_0 be the connected component of \mathcal{G} containing the identity. One can show that CS is invariant under \mathcal{G} . However, CS is not invariant under a generator of $\mathcal{G}/\mathcal{G}_0 \simeq \mathbb{Z}$, it picks up a multiple of 2π .

Hence, for every $k \in \mathbb{Z}$, the expression

$$e^{ikCS(A)}$$

is a well defined function of A . **Witten's invariant** of three dimensional manifolds can be defined formally as the 'partition function'

$$Z(M) = \int_{\mathcal{C}/\mathcal{G}} e^{ikCS(A)} dA$$

provided one believes that the integral makes sense.

More generally, suppose we have an oriented curve C contained in M . A connection $\nabla = d + A$ on M defines a connection on C by restriction. Running around the curve C then gives a **monodromy** element $Mon_C(A)$. Then,

$$Tr_V Mon_C(A) = W_C(A)$$

is known as a **Wilson line** where Tr_V is taking the trace in an irreducible representation V of G . Then, one can define an invariant for the embedding of C in M by

$$Z(M, C) = \int_{\mathcal{C}/\mathcal{G}} e^{ikCS(A)} W_C(A) dA$$

which leads to new **knot invariants**.

In the easiest case, that is when $M = S^3$ the three sphere, $G = SU_2(\mathbb{C})$ and V is the 2-dimensional representation of $SU_2(\mathbb{C})$ one recovers the famous **Jones polynomial** of the knot C embedded in S^3 (which can be seen as a one point compactification of \mathbb{R}^3 thereby giving a new knot invariant).

The Jones polynomial $V_K(t)$ is an element of $\mathbb{Z}[t, t^{-1}]$ assigned to a knot K in \mathbb{R}^3 . It is normalized so that it assigns 1 to the unknot, the standard unknotted circle in \mathbb{R}^3 . Moreover, it has the key property

$$V_{K^*}(t) = V_K(t^{-1})$$

where K^* is the mirror image of K .

Simple examples show that $V_K(t)$ need not be invariant under $t \mapsto t^{-1}$, so that the Jones polynomial can sometimes distinguish knots from their mirror images.

The Alexander polynomial (which was basically the only knot invariant known before 1984!) on the other hand always takes the same value for a knot and its mirror image.

For example, the right handed trefoil knot T

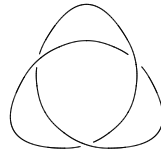

has Jones polynomial

$$V_T(t) = t + t^3 - t^4$$

and so distinguishes from its mirror image T^*

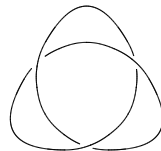

Vaughan Frederick Randal Jones

Born : 31 december 1952 in Gisborne (New Zealand)



In 1970 Vaughan Jones entered the University of Auckland graduating with a B.Sc. in 1972 and an M.Sc. with First Class Honours in 1973. After teaching for a while as an assistant lecturer at Auckland, he entered the Ecole de Physique in Geneva in 1974, moving in 1976 to the Ecoles Mathematiques. In Geneva his research was supervised by A Haefliger and he also taught as an assistant. In 1979 Jones was awarded his Docteur es Sciences (Mathematique), and the following year he was awarded the Vacheron Constantin Prize for his doctoral

thesis. Jones worked on the Index Theorem for von Neumann algebras, continuing work begun by Connes and others. His most remarkable contribution, however, was that in the course of this work he discovered a new polynomial invariant for knots which led to surprising connections between apparently quite different areas of mathematics. Jones was awarded a Fields Medal at the 1990 International Congress in Kyoto, Japan for his remarkable and beautiful mathematical achievements. Jones gave a lecture to the 1990 Congress dressed in a rather unusual way for a mathematics lecture. He was wearing the "All Blacks" rugby strip! In 1984 Jones discovered an astonishing relationship between von Neumann algebras and geometric topology. As a result, he found a new polynomial invariant for knots and links in 3-space. His invariant had been missed completely by topologists, in spite of intense activity in closely related areas during the preceding 60 years, and it was a complete surprise. As time went on, it became clear that his discovery had to do in a bewildering variety of ways with widely separated areas of mathematics and physics. These included (in addition to knots and links) that part of statistical mechanics having to do with exactly solvable models, the very new area of quantum groups, and also Dynkin diagrams and the representation theory of simple Lie algebras. The central connecting link in all this mathematics was a tower of nested algebras which Jones had discovered some years earlier in the course of proving a theorem which is known as the "Index Theorem".

If we represent a knot (or more generally a link) by a general plane projection with over- and undercrossings, the Jones polynomial can be characterized and computed by a **skein relation**.

Given any oriented link diagram L and a crossing point, we can alter the crossing to produce three different diagrams as indicated

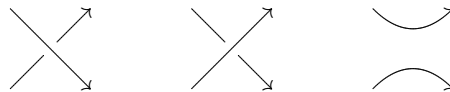

which we denote resp. with L_+ , L_- and L_0 . Let V_+ , V_- and V_0 denote the Jones polynomials of these links. Then the skein relation is

$$t^{-1}V_+ - tV_- = (t^{\frac{1}{2}} - t^{-\frac{1}{2}})V_0$$

There is no obvious reason why this relation should define a link invariant, it might depend on the plane presentation. However, one can show that it is invariant by verifying that it is invariant under each of the **Reidemeister moves**.

There is a reason why invariants of knots (and links) and invariants of three dimensional compact manifolds are related. A classical theorem due to Lickorish and Wallace asserts that any closed connected oriented 3-manifold can be obtained by **surgery** on the three sphere S^3 along a certain link. We will briefly outline the surgery operation.

Let L be a link in S^3 with m components L_1, \dots, L_m . Let U be the closed regular neighborhood of L in S^3 consisting of m disjoint solid tori U_1, \dots, U_m whose cores are the corresponding components of L .

Observe that a solid torus is a topological space homeomorphic to

$$S^1 \times B^2$$

where B^2 is the closed 2-disk. Identify each U_j with $S^1 \times B^2$ such that L_j is identified to $S^1 \times \{0\}$ where 0 is the center of B^2 .

Let B^4 be a closed 4-ball, which is a four dimensional manifold with boundary $\partial B^4 = S^3$. We have $U \subset S^3 = \partial B^4$. A **2-handle** is a topological space homeomorphic to

$$B^2 \times B^2$$

Now, glue m copies of the 2-handle to B^4 along the identification

$$U_j = S^1 \times B^2 = \partial B^2 \times B^2$$

This gluing results in a compact connected four dimensional manifold (with boundary !) which we will denote by M_L . The closed connected three dimensional manifold ∂M_L is formed by $S^3 - \text{Int}(U)$ and m copies of $B^2 \times \partial B^2$ glued to $S^3 - \text{Int}(U)$ along the boundary.

Definition 5.26 *With notations as above, we say that the three dimensional manifold ∂M_L is obtained by surgery on S^3 along the link L .*

To combine surgery with knot invariants to obtain topological invariants of three dimensional manifolds we have to pass from links in $S^3 = \mathbb{R}^3 \cup \{\infty\}$ to links in \mathbb{R}^3 . Fortunately, any link in S^3 may be deformed into \mathbb{R}^3 and isotopic links in S^3 give rise to isotopic links in \mathbb{R}^3 .

In order to understand three dimensional manifolds (for example, to (dis)prove the three dimensional Poincaré conjecture) we therefore need to find many new knot invariants. Witten's geometrical approach has the potential for doing this but we have seen that the definition is not entirely mathematical rigorous (as the quotient space \mathcal{C}/\mathcal{G} is not nice).

Still, Reshitikhin and Turaev have shown that one can make a mathematical sound construction following Witten's suggestion. Their construction uses properties of the representation theory of **quantum groups** introduced by Drinfeld. These quantum groups are deformations of the enveloping algebras of semi-simple Lie algebras.

Let us describe the easiest case, that of $U_q(\mathfrak{sl}_2)$, leading to the Jones invariant. The Lie algebra of $SU_2(\mathbb{C})$ is \mathfrak{sl}_2 . It is a three dimensional vectorspace with basis $\{X, Y, H\}$ and brackets

$$[X, Y] = H, \quad [H, X] = 2X, \quad [H, Y] = -2Y$$

The (complex) enveloping algebra $U(\mathfrak{sl}_2)$ of \mathfrak{sl}_2 is the non-commutative algebra over \mathbb{C} generated by three (noncommuting) variables, $\{X, Y, H\}$ satisfying the

commutation relations

$$XY - YX = H, HX - XH = 2X \text{ and } HY - YH = -2Y$$

The quantum group $U_q(\mathfrak{sl}_2)$ is the non-commutative algebra over \mathbb{C} generated by indeterminates E, F, K, K^{-1} and L satisfying the commutation relations

$$EF - FE = L, LE - EL = q(EK + K^{-1}E), LF - FL = -q^{-1}(FK + K^{-1}F)$$

$$KK^{-1} = K^{-1}K = 1, KE = q^2EK, KF = q^{-2}FK, K - K^{-1} = (q - q^{-1})L$$

where $q \in \mathbb{C}^*$. One verifies that if $q \rightarrow 1$ and if $K = 1$ then we recover the enveloping algebra $U(\mathfrak{sl}_2)$.

The representation theory of these quantum groups is similar to those of enveloping algebras for generic values of q but is particularly rich when q is a root of unity. This case leads to knot invariants and the appearance of roots of unity should be compared to the appearance of $k \in \mathbb{Z}$ in the Witten invariants.

Vladimir Gerschonovich Drinfeld

Born : 1954 in Kharkov (Ukraine)



Vladimir Drinfeld studied at Moscow University from 1969 until 1974. He graduated in 1974 and remained at Moscow University to undertake research under Yuri Ivanovich Manin's supervision. Drinfeld completed his postgraduate studies in 1977 and he defended his thesis in 1978. On 21 August 1990 Drinfeld was awarded a Fields medal at the International Congress of Mathematicians in Kyoto, Japan for his work on quantum groups and for his work in number theory. Drinfeld defies any easy classification. His breakthroughs have the magic that one would expect of a revolutionary mathematical discovery: they have seemingly inexhaustible consequences. On the other hand, they seem deeply personal pieces of mathematics: "only Drinfeld could have thought of them!" But contradictorily they seem transparently natural; once understood, "everyone should have thought of them!" Drinfeld's main achievements are his proof of the Langlands conjecture for $GL(2)$ over a function

field; and his work in quantum group theory. The interactions between mathematics and mathematical physics studied by Atiyah led to the introduction of instantons - solutions, that is, of a certain nonlinear system of partial differential equations, the self-dual Yang-Mills equations, which were originally introduced by physicists in the context of quantum field theory. Drinfeld and Manin worked on the construction of instantons using ideas from algebraic geometry.

6 Noncommutative manifolds

The notion of a differentiable manifold is only as natural as it resembles physical space(time). However, there are indications that this cannot be the full story. For example, there is an asymmetry in elementary particles. There are left handed and right handed particles which behave different with respect to the weak force. It has been suggested that physical space-time should therefore really look like two sheets of Minkowski space, extremely close together and interacting. More generally, one would like to define a workable geometry on products of manifolds with discrete spaces.

Noncommutative geometry, as developed by A. Connes, may very well be such a theory. The basic idea is easy to state : one replaces a manifold by an algebra $C(M)$ of complex valued smooth functions on M . Then, one can recover the topological space M back from the algebra. However, in order to do physics we would also like to recover the differential and Riemannian structure. In particular, we would like to recover the notion of geodesics. In order to achieve this one looks at a particular representation of the algebra $C(M)$ corresponding to the Dirac operator D . The couple $(C(M), D)$ contains enough information to recover the metric structure of M (and much more).

Having reduced everything to algebra, we can then consider the same data where we replace the commutative algebra $C(M)$ by a non-commutative algebra A (with suitable extra conditions).

In particular one can study finite point geometries as noncommutative manifolds. Connes studied the 'eigenschaft' algebra

$$A = \mathbb{C} \oplus \mathbb{H} \oplus M_3(\mathbb{C})$$

where \mathbb{H} are the Hamilton quaternions, and considered the product of this finite geometry with usual space-time. It turned out that the natural way to do physics on this noncommutative variety (by studying Yang-Mills connections) led to the standard model in particle physics.

It is also believed that the underlying 'symmetry' of this noncommutative manifold is no longer determined by a Lie group but instead by a quantum group.

6.1 C^* -algebras and topology.

We will consider a complex algebra A , that is, A is a complex vectorspace equipped with an addition and multiplication satisfying the usual properties (although we do not demand that the multiplication should be commutative).

The algebra A is called a ***-algebra** provided there is an antilinear involution

$$* : A \longrightarrow A$$

satisfying the following properties

$$(a^*)^* = a, (ab)^* = b^*a^*, (\alpha a + \beta b)^* = \bar{\alpha}a^* + \bar{\beta}b^*$$

for all $a, b \in A$, $\alpha, \beta \in \mathbb{C}$ and where $\bar{\cdot}$ is complex conjugation. A **normed algebra** A is an algebra admitting a norm

$$\| \cdot \|: A \longrightarrow \mathbb{R}$$

such that for all $a, b \in A$ and $\alpha \in \mathbb{C}$ we have

$$\| a \| \geq 0, \| a \| = 0 \Leftrightarrow a = 0, \| \alpha a \| = |\alpha| \| a \|^2$$

$$\| a + b \| \leq \| a \| + \| b \|, \| ab \| \leq \| a \| \| b \|^2$$

The topology on A defined by this norm is called the **norm topology**.

A **Banach algebra** is a normed algebra which is complete with respect to the norm topology and a **C^* -algebra** is a Banach $*$ -algebra such that for all $a \in A$ one has

$$\| a^* \| = \| a \| \quad \text{and} \quad \| a^* a \| = \| a \|^2$$

Example 6.1 Let M be a compact manifold and consider $C(M)$ the algebra of continuous complex-valued functions on M . $C(M)$ is a $*$ -algebra by taking point-wise complex-conjugation and is normed by the **supremum norm**

$$\| f \|_\infty = \sup_{p \in M} |f(p)|$$

$C(M)$ is a C^* -algebra.

Example 6.2 Let \mathcal{H} be a Hilbert space. The noncommutative algebra $B(\mathcal{H})$ of bounded linear operators has an involution $*$ given by the adjoint and a norm given by the **operator norm**

$$\| B \| = \sup\{\| B(h) \|: h \in \mathcal{H}, \| h \| \leq 1\}$$

In particular, if $\mathcal{H} = \mathbb{C}^n$, then $B(\mathcal{H}) = M_n(\mathbb{C})$, the involution T^* of a matrix T is the Hermitian conjugate, that is,

$$T^* = (\overline{t_{ji}})_{i,j} \quad \text{when} \quad T = (t_{ij})_{i,j}$$

and the norm can be written as

$$\| T \| = \sqrt{\lambda} \quad \text{where } \lambda \text{ is the largest eigenvalue of } T^* T$$

The norm on a C^* -algebra A is uniquely determined by the algebraic structure,

$$\| x \| = \sup\{|\lambda|: xx^* - \lambda \notin A^*\}$$

where A^* is the group of invertible elements of A , the right hand side is called the **spectral radius** of x .

For a $*$ -algebra A to be a C^* -algebra it is necessary and sufficient that it admits a faithful $*$ -representation π on a Hilbert space \mathcal{H} , that is an involution preserving algebra morphism

$$\pi : A \longrightarrow B(\mathcal{H})$$

such that if $\pi(a) = 0$ then $a = 0$ and $\pi(A)$ is norm closed.

If A is a commutative C^* -algebra, we denote by $Sp A$ the **spectrum** of A the set of all $*$ -representations $A \longrightarrow \mathbb{C}$ equipped with the topology of pointwise convergence on A . That is, a sequence χ_i in $Sp A$ converges iff the sequence $\chi_i(a)$ converges in \mathbb{C} for all $a \in A$. It can be shown that $Sp A$ is a compact Hausdorff space. Moreover, we have the celebrated Gel'fand-Naimark theorem.

Theorem 6.3 *Let A be a commutative C^* -algebra and $X = Sp A$ its spectrum. Then A is isomorphic to the C^* -algebra $C(X)$ of continuous complex functions on X . The isomorphism is given by sending $a \in A$ to the function \hat{a} which is evaluation at a .*

Thus, the contravariant functor C that associates to a compact space X the C^* -algebra $C(X)$ effects an equivalence between the category of compact spaces with continuous mappings and the opposite of the category of commutative C^* -algebras. To a continuous map $X \xrightarrow{f} Y$ there corresponds a homomorphism

$$C(f) : C(Y) \longrightarrow C(X)$$

given by composition. In particular, two commutative C^* -algebras are isomorphic if and only if their spectra are homeomorphic.

Returning to our problem of reconstructing the manifold M from algebraic data, we have already reconstructed the topology on M from the C^* -algebra $C(M)$ of continuous complex functions on M .

6.2 The Dirac operator

In this section we will recover the metric structure on suitable Riemannian manifolds from algebraic data.

Let M be a compact oriented manifold of dimension n . Consider the Levi-Civita connection on M and write it as

$$\nabla = d + A$$

with $A \in \Omega^1(Ad TM)$, that is, a one form with values in the Lie algebra \mathfrak{so}_n . Now, consider a vectorbundle E on M with a bundle metric $\langle \cdot, \cdot \rangle$ on which the Lie group $SO_n(\mathbb{R})$ acts by isometries. If A is a one form with values in \mathfrak{so}_n , then we can define a metric connection $\nabla = d + A$ on E .

Hence, for any such vectorbundle E on which $SO_n(\mathbb{R})$ acts with the same transition functions as for TM , the Levi-Civita connection induces a metric connection on E .

Now apply this to the Clifford bundles

$$Cl(P) = P \times_{SO_n(\mathbb{R})} Cl(\mathbb{R}^n) \text{ and } Cl^c(P) = P \times_{SO_n(\mathbb{R})} Cl^c(\mathbb{R}^n)$$

where P is the frame bundle of M . Then, the Levi-Civita connection induces a connection on each of these Clifford bundles which we again denote by ∇ . One can prove that this connection acts as a derivation on sections.

Lemma 6.4 *For smooth sections μ, ν of the Clifford bundles we have*

$$\nabla(\mu.\nu) = \nabla(\mu)\nu + \mu\nabla(\mu)$$

Suppose now that M has a spin structure \tilde{P} , then we can repeat the same procedure to obtain an induced connection ∇ on the associated spinor bundle \mathcal{S}_n . There is an action of $Cl^c(P)$ on the spinor bundle \mathcal{S}_n via fiberwise Clifford multiplication and this action is compatible with these Levi-Civita connections.

Lemma 6.5 *For sections μ of $Cl^c(P)$ and σ of \mathcal{S}_n we have*

$$\nabla(\mu.\sigma) = \nabla(\mu).\sigma + \mu.\nabla(\sigma)$$

Suppose that in a local trivialization of TM we can write

$$A = \sum_{i < j} \Omega_{ij} e_i \wedge e_j$$

for skew symmetric matrices Ω_{ij} and where $e_i \wedge e_j$ is the matrix m with $m_{ij} = -1$, $m_{ji} = 1$ and zeroes elsewhere. Now, $e_i \wedge e_j \in \mathfrak{so}_n$ corresponds to $\frac{1}{2}e_i e_j \in \mathfrak{spin}_n$ and hence the connection on the spinor bundle with respect to the induced local trivialization is given by

$$\nabla = d + \frac{1}{2} \sum_{i < j} \Omega_{ij} e_i e_j$$

where $e_i e_j$ acts by Clifford multiplication on spinors.

Now we are in a position to define the Dirac operator. Consider the extended Levi-Civita connection

$$\nabla : \Gamma(\mathcal{S}_n) \longrightarrow \Gamma(T^*M \otimes \mathcal{S}_n)$$

Further we have the Clifford multiplication

$$m : TM \otimes \mathcal{S}_n \longrightarrow \mathcal{S}_n$$

given by $v \otimes \sigma = v.\sigma$. Finally, we can use the Riemannian metric to identify TM with T^*M using the non-degenerate quadratic form $(g_{ij})_{i,j}$.

We can combine all these maps to define

Definition 6.6 *The Dirac operator of M is the composition*

$$\Gamma(\mathcal{S}_n) \xrightarrow{\nabla} \Gamma(T^* \otimes \mathcal{S}_n) \simeq \Gamma(TM \otimes \mathcal{S}_n) \xrightarrow{m} \Gamma(\mathcal{S}_n)$$

Paul Adrien Maurice Dirac

Born : 8 august 1902 in Bristol (England)

Died : 20 october 1984 in Talahassee, Florida (USA)



Paul Dirac is famous as the creator of the complete theoretical formulation of quantum mechanics. He studied electrical engineering at the University of Bristol before doing research in mathematics at St John's College Cambridge. His first major contribution to quantum theory was a paper written in 1925. He published "The principles of Quantum Mechanics" in 1930 and for this work he was awarded the Nobel Prize for Physics in 1933. Dirac was appointed Lucasian professor of mathematics at the University of Cambridge in 1932, a post he held for 37 years. He was made a fellow of the Royal Society in 1930, was awarded the Royal Society's Royal Medal in 1939 and the Society awarded him the Copley Medal in 1952 "... in recognition of his remarkable contributions to relativistic dynamics of a particle in quantum mechanics." In 1971 Dirac was appointed professor of physics at Florida State University and was appointed to the Order of Merit in 1973.

We will now use the Dirac operator to define a $*$ -representation of $C(M)$. As \mathcal{S}_n is a vectorbundle over M having complex vectorspaces as fibers, its sections $\Gamma(\mathcal{S}_n)$ is clearly a complex vectorspace. With $\mathcal{H} = L^2(M, \mathcal{S}_n)$ we denote the subspace of $\Gamma(\mathcal{S}_n)$ of square integrable sections of \mathcal{S}_n .

\mathcal{H} is a Hilbert space with norm induced by the inproduct

$$(\phi, \psi) = \int_M \langle \overline{\phi(p)}, \psi(p) \rangle dp$$

where $\langle \cdot, \cdot \rangle$ is the natural inproduct on the spinor space. One can show that the Dirac operator maps \mathcal{H} into itself, that D is a **self-adjoint** operator on \mathcal{H} . Further, $C(M)$ act as bounded operators on \mathcal{H} by the rule

$$(f\phi)(p) = f(p)\phi(p)$$

for all $f \in C(M), \phi \in \mathcal{H} \subset \Gamma(\mathcal{S}_n)$ and all $p \in M$. This gives rise to a $*$ -representation

$$C(M) \xrightarrow{\pi} B(\mathcal{H})$$

which is faithful, that is, we can view $C(M)$ as a subspace of \mathcal{H} .

The Dirac operator itself is not a bounded operator on \mathcal{H} but the important property one can prove is that the operator

$$[D, f] = D \circ f - f \circ D : \mathcal{H} \longrightarrow \mathcal{H}$$

is a bounded operator for all $f \in C(M)$.

The reconstruction of the metric structure on M from the triple $(C(M), \mathcal{H}, D)$ follows from the following result.

Theorem 6.7 *The geodesic distance between any two points $p, q \in M$ is given by the formula*

$$d(p, q) = \sup_{f \in C(M)} \{|f(p) - f(q)| : \| [D, f] \| \leq 1\}$$

6.3 Connes' standard model.

Having recovered the compact oriented manifold M with spinstructure from algebraic data, we can use this algebraic data to generalize the notion of manifolds to the noncommutative case.

Definition 6.8 *A noncommutative manifold is a triple*

$$(A, \mathcal{H}, D)$$

where A is a C^* -algebra (or more generally, a $*$ -algebra), \mathcal{H} is a Hilbert space such that there is a faithful $*$ -representation

$$A \xrightarrow{\pi} B(\mathcal{H}).$$

D is a self adjoint operator on \mathcal{H} with the property that for all $a \in A$

$$[D, \pi(a)]$$

is a bounded operator on \mathcal{H} .

Actually, in this generality one has to put further technical restrictions on the triple. However, all noncommutative manifolds we will encounter here are products of usual manifolds with finite noncommutative spaces and then these extra assumptions are automatically satisfied.

Let us begin by giving some manifold structures on finite sets.

Example 6.9 Consider two points $M = \{a, b\}$. Then, $A = C(M) = \mathbb{C} \times \mathbb{C}$ the correspondence being given by $f \mapsto (f(a), f(b))$. The Hilbert space $\mathcal{H} = \mathbb{C}^2$ and the $*$ -representation is given by

$$\pi : A \longrightarrow M_2(\mathbb{C}) \quad f \mapsto \begin{bmatrix} f(a) & 0 \\ 0 & f(b) \end{bmatrix}$$

Finally, we take as a Dirac operator

$$D = \begin{bmatrix} 0 & \mu \\ \mu & 0 \end{bmatrix} \quad \text{with } \mu \in \mathbb{R}_{>0}$$

Then, D is a self adjoint operator and we have for all $f \in A$

$$\begin{aligned} [D, f] &= \begin{bmatrix} 0 & \mu \\ \mu & 0 \end{bmatrix} \begin{bmatrix} f(a) & 0 \\ 0 & f(b) \end{bmatrix} - \begin{bmatrix} f(a) & 0 \\ 0 & f(b) \end{bmatrix} \begin{bmatrix} 0 & \mu \\ \mu & 0 \end{bmatrix} \\ &= \begin{bmatrix} 0 & -\mu(f(a) - f(b)) \\ \mu(f(a) - f(b)) & 0 \end{bmatrix} \end{aligned}$$

And therefore we have for the operator norm that

$$\| [D, f] \| = \mu | f(a) - f(b) |$$

and therefore if this norm is ≤ 1 then $| f(a) - f(b) | \leq \frac{1}{\mu}$. Generalizing the distance function to this context we then have

$$d(a, b) = \frac{1}{\mu}$$

Recall that at this moment physics recognizes four fundamental forces : gravitation, electromagnetism, the weak force (responsible for radiative decay) and the strong force (holds the kernel of atoms together). Each of these forces is carried by 'bosons'. Present boson-knowledge is summarized in

	name	symb	mass	charge	#
spin 0	Higgs	H^0	≥ 50000	0	1
spin 1	foton vectorb.	γ	0	0	1
		Z^0	91177	0	1
		W^+	80600	+	1
		W^-	80600	-	1
	gluons	A_s	0	0	8
spin 2	graviton	g	0	0	1

The fact that there are three vectorbosons and 8 gluons is a consequence of the fact that the underlying symmetry groups are $SU_2(\mathbb{C})$ (dimension 3) and $SU_3(\mathbb{C})$ (dimension 8). Bosons have integral spin and satisfy Bose statistics (many identical particles possible).

On the other hand, matter is made up of fermions, which have half integral spin and satisfy Fermi statistics (no identical particles possible).

Surprisingly, nature seems to repeat itself and so there are thought to be three generations of elementary particles, each having their leptons and quarks.

Present knowledge about the spin $\frac{1}{2}$ leptons is summarized in the table below

	<i>name</i>	<i>symb</i>	<i>mass</i>	<i>charge</i>	#
<i>gen I</i>	<i>e – neutrino</i>	ν_e	~ 0	0	1
	<i>electron</i>	e	0.511003	–	1
<i>gen II</i>	μ – <i>neutrino</i>	ν_μ	~ 0	0	1
	<i>muon</i>	μ	105.6593	–	1
<i>gen III</i>	τ – <i>neutrino</i>	ν_τ	~ 0	0	1
	<i>tau</i>	τ	1784	–	1

Present knowledge about the spin $\frac{1}{2}$ quarks is summarized in

	<i>name</i>	<i>symb</i>	<i>mass</i>	<i>charge</i>	#
<i>gen I</i>	<i>up</i>	u	5	$\frac{2}{3}$	3
	<i>down</i>	d	10	$-\frac{1}{3}$	3
<i>gen II</i>	<i>charm</i>	c	1600	$\frac{2}{3}$	3
	<i>strange</i>	s	180	$-\frac{1}{3}$	3
<i>gen III</i>	<i>top</i>	t	170000	$\frac{2}{3}$	3
	<i>bottom</i>	b	5000	$-\frac{1}{3}$	3

The underlying symmetry of the standard model (that is, a unified theory for all forces except gravitation) is believed to be the Lie group

$$U(1) \times SU_2(\mathbb{C}) \times SU_3(\mathbb{C})$$

To see how it acts on the elementary particles it is best to represent each generation in a table (below we do it for the first generation, others behave the same)

$\begin{pmatrix} \nu_e \\ e \end{pmatrix}_L$	$\begin{pmatrix} u \\ d \end{pmatrix}_L^r$	$\begin{pmatrix} u \\ d \end{pmatrix}_L^y$	$\begin{pmatrix} u \\ d \end{pmatrix}_L^b$
e_R	$\{u_R^r, d_R^r\}$	$\{u_R^y, d_R^y\}$	$\{u_R^b, d_R^b\}$

Here the subindices L and R indicate left- resp. righthanded particles, the upper indices r, y, b indicate the three flavours of quarks (red, yellow and blue). The color group $SU_3(\mathbb{C})$ interchanges the last three coloms and the electroweak group $U(1) \times SU_2(\mathbb{C})$ acts on the rows.

Using these physical facts, A. Connes proposed the following finite noncommutative manifold

$$(\mathbb{C} \oplus \mathbb{H} \oplus M_3(\mathbb{C}), \mathbb{C}^{90}, D)$$

where the 'eigenschaften' algebra is involutive (but not a \mathbb{C} -algebra) where $\mathbb{H} = Cl(\mathbb{R}^2)$ is the subalgebra of $M_2(\mathbb{C})$ consisting of matrices of the form

$$\mathbb{H} = \left\{ \begin{bmatrix} \alpha & \beta \\ -\bar{\beta} & \bar{\alpha} \end{bmatrix} \mid \alpha, \beta \in \mathbb{C} \right\}$$

The involutions are the standard involutions on $M_n(\mathbb{C})$ (which preserves \mathbb{H}). The Hilbert space is of dimension 90. Observe that each generation has 15 distinct elementary particles, we let \mathcal{E} be the vectorspace spanned by these 45 elementary particles. With the complex conjugate space $\bar{\mathcal{E}}$ we denote the vectorspace spanned by the 45 antiparticles. Elements of $\bar{\mathcal{E}}$ are of the form $\bar{\zeta}$ with $\zeta \in \mathcal{E}$. Action of $\lambda \in \mathbb{C}$ on $\bar{\mathcal{E}}$ is given by $\lambda \cdot \bar{\zeta} = \overline{\lambda \cdot \zeta}$. The physical Hilbert space

$$\mathcal{H} = \mathcal{E} \oplus \bar{\mathcal{E}} \simeq \mathbb{C}^{90}$$

In order to define a $*$ -representation

$$\mathbb{C} \oplus \mathbb{H} \oplus M_3(\mathbb{C}) \longrightarrow M_{90}(\mathbb{C})$$

we have to define an action of the algebra on \mathcal{E} and its conjugate. The action of (λ, q, m) is given on the basevectors of \mathcal{E} by the following rules

$$u_R \mapsto \lambda u_R, d_R \mapsto \bar{\lambda} d_R, e_R \mapsto \bar{\lambda} e_R$$

$$\begin{pmatrix} \nu_L & u_L \\ e_L & d_L \end{pmatrix} \mapsto q \cdot \begin{pmatrix} \nu_L & u_L \\ e_L & d_L \end{pmatrix}$$

and similarly for the other generations. The action of (λ, q, m) on $\bar{\mathcal{E}}$ is given by the rules

$$(\bar{\nu} \quad \bar{e}_L \quad \bar{e}_R) \mapsto \lambda \cdot (\bar{\nu} \quad \bar{e}_L \quad \bar{e}_R)$$

$$\begin{pmatrix} \bar{u}_L^r & \bar{u}_R^r \\ \bar{u}_L^y & \bar{u}_R^y \\ \bar{u}_L^b & \bar{u}_R^b \end{pmatrix} \mapsto m. \begin{pmatrix} \bar{u}_L^r & \bar{u}_R^r \\ \bar{u}_L^y & \bar{u}_R^y \\ \bar{u}_L^b & \bar{u}_R^b \end{pmatrix}$$

Finally, the Dirac operator has the following form in the decomposition $\mathcal{E} \oplus \bar{\mathcal{E}}$

$$D = \begin{bmatrix} Y & 0 \\ 0 & \bar{Y} \end{bmatrix}$$

where Y is the so called Yukawa coupling matrix which has the following form for one generation. Here, we use the ordered basis

$$\{u_L^r, u_L^y, u_L^b, d_L^r, d_L^y, d_L^b, u_R^r, u_R^y, u_R^b, d_R^r, d_R^y, d_R^b, e_L, \nu_L, e_R\}$$

$$Y = \begin{vmatrix} 0 & 0 & 0 & 0 & 0 & 0 & M_u & 0 & 0 & 0 & 0 & 0 & 0 & 0 & 0 \\ 0 & 0 & 0 & 0 & 0 & 0 & 0 & M_u & 0 & 0 & 0 & 0 & 0 & 0 & 0 \\ 0 & 0 & 0 & 0 & 0 & 0 & 0 & 0 & M_u & 0 & 0 & 0 & 0 & 0 & 0 \\ 0 & 0 & 0 & 0 & 0 & 0 & 0 & 0 & 0 & M_d & 0 & 0 & 0 & 0 & 0 \\ 0 & 0 & 0 & 0 & 0 & 0 & 0 & 0 & 0 & 0 & M_d & 0 & 0 & 0 & 0 \\ 0 & 0 & 0 & 0 & 0 & 0 & 0 & 0 & 0 & 0 & 0 & M_d & 0 & 0 & 0 \\ M_u^* & 0 & 0 & 0 & 0 & 0 & 0 & 0 & 0 & 0 & 0 & 0 & 0 & 0 & 0 \\ 0 & M_u^* & 0 & 0 & 0 & 0 & 0 & 0 & 0 & 0 & 0 & 0 & 0 & 0 & 0 \\ 0 & 0 & M_u^* & 0 & 0 & 0 & 0 & 0 & 0 & 0 & 0 & 0 & 0 & 0 & 0 \\ 0 & 0 & 0 & M_d^* & 0 & 0 & 0 & 0 & 0 & 0 & 0 & 0 & 0 & 0 & 0 \\ 0 & 0 & 0 & 0 & M_d^* & 0 & 0 & 0 & 0 & 0 & 0 & 0 & 0 & 0 & 0 \\ 0 & 0 & 0 & 0 & 0 & M_d^* & 0 & 0 & 0 & 0 & 0 & 0 & 0 & 0 & 0 \\ 0 & 0 & 0 & 0 & 0 & 0 & M_d^* & 0 & 0 & 0 & 0 & 0 & 0 & 0 & 0 \\ 0 & 0 & 0 & 0 & 0 & 0 & 0 & 0 & 0 & 0 & 0 & 0 & 0 & 0 & M_e \\ 0 & 0 & 0 & 0 & 0 & 0 & 0 & 0 & 0 & 0 & 0 & 0 & 0 & 0 & 0 \\ 0 & 0 & 0 & 0 & 0 & 0 & 0 & 0 & 0 & 0 & 0 & 0 & M_e^* & 0 & 0 \end{vmatrix}$$

For three generations, M_u, M_d and M_e are 3×3 matrices which encode masses of the fermions and their mixing properties.

The final ingredient of Connes' construction is the notion of a product of noncommutative manifolds. Suppose we have two noncommutative manifolds

$$(A_1, \mathcal{H}_1, D_1) \quad \text{and} \quad (A_2, \mathcal{H}_2, D_2)$$

then one can define the product manifold to be determined by the triple

$$(A_1 \otimes_{\mathbb{C}} A_2, \mathcal{H}_1 \otimes_{\mathbb{C}} \mathcal{H}_2, D_1 \otimes id_2 + id_1 \otimes D_2)$$

and one verifies that this triple satisfies all the requirements.

The **noncommutative standard model** of Connes is then given by taking the product of a four dimensional compact oriented spin manifold M (space time) as described by the triple

$$(C(M), L^2(M, \mathcal{S}_4), D_M)$$

with the finite noncommutative manifold introduced above.

One can then generalize connections in this setting and compute Lagrangians etc. It turns out that the resulting Lagrangian has the same form as given by the standard model but with several appealing extra properties. For example, at this moment there is no experimental fact supporting the existence of the Higgs boson (without which the standard model would fail because all vectorbosons should have zero mass, quod non). In Connes model, the Higgs field appears naturally as the part of the connection determined by the finite geometry.

A major open problem is to determine the symmetry groups underlying this noncommutative manifold. Connes has proposed an algebra closely related to the quantum group $U_q(\mathfrak{sl}_2)$ with q a third root of unity as a possible symmetry.

Alain Connes

Born : 1 april 1947 in Draguignan (France)



Alain Connes became a researcher at the Centre National de la Recherche Scientifique. His thesis "A classification of factors of type III" was on operator algebras, in particular on von Neumann algebras, and the work was supervised by Jacques Dixmier. The thesis was presented to the Ecole Normale Supérieure in 1973. In 1981 Connes returned to the Centre National de la Recherche Scientifique, this time as its director of research. He held this post for eight years. Another position he was appointed to was professor at the Collège de France at Rue d'Ulm in Paris in 1984. To place Alain Connes's fundamental and pioneering contributions to operator algebras in context, recall that von Neumann and Murray in the 1930s and 1940s were led by, among other things, the spectral theory of operators on Hilbert space, and by considerations of constructing mathematical models for quantum mechanical systems, to introduce what they called rings of operators - since renamed von Neumann algebras. One of the main problems has been and remains the classification of these algebras as intrinsic algebraic and topological objects. Connes' thesis is a major, stunning breakthrough in the classification problem. One of the first major international distinctions for Connes was an invitation to give one of the invited lectures at the International Congress in Helsinki in 1978. Four years later the award of a Fields Medal to Connes was

announced at a meeting of the General Assembly of the International Mathematical Union in Warsaw in early August 1982. Connes' most remarkable contributions are (1) general classification and a structure theorem for factors of type III, obtained in his thesis (2) classification of automorphisms of the hyperfinite factor, which served as a preparation for the next contribution (3) classification of injective factors, and (4) application of the theory of C^* -algebras to foliations and differential geometry in general. Connes' recent work has been on noncommutative geometry and he published a major text on the topic in 1994. He has studied applications to theoretical physics and his work is of major importance.

References

The material for these notes were taken from the following sources

- C. Adams "The knot book"
- M. Artin "Algebra"
- M. Atiyah "The geometry and physics of knots"
- A. Connes "Noncommutative Geometry"
- N. Hicks "Notes on differential geometry"
- J. Jost "Riemannian Geometry and Geometric Analysis"
- G. Landi "An introduction to noncommutative spaces and their geometry"
- H. Blaine Lawson Jr. "The theory of gauge fields in four dimensions"
- W.S. Massey "Algebraic topology, an introduction"
- V.G. Turaev "Quantum invariants of knots and 3-manifolds"

The biographic material was taken from

"[http://www-history.mcs.st-andrews.ac.uk/ history/Mathematicians/](http://www-history.mcs.st-andrews.ac.uk/history/Mathematicians/)"